

Compaq MV7500

SERVICE MANUAL

LG: CA-110

LG CQ771G

**MODEL: S7500 (PE1165T), S7500 (PE1165),
MV7500 (PE1165U), MV7500 (PE1165),
CV7500 (PE1165U)**

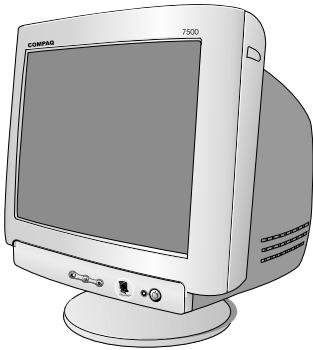

CONTENTS

SPECIFICATIONS	2	ADJUSTMENT	10
SAFETY PRECAUTIONS	3	TROUBLESHOOTING GUIDE	12
TIMING CHART	4	EXPLODED VIEW.....	22
OPERATING INSTRUCTIONS	5	REPLACEMENT PARTS LIST	24
WIRING DIAGRAM	6	PIN CONFIGURATION.....	29
BLOCK DIAGRAM	7	PACKING AND ACCESSORIES	31
DESCRIPTION OF BLOCK DIAGRAM.....	8	SCHEMATIC DIAGRAM.....	32
		PRINTED CIRCUIT BOARD.....	34

SPECIFICATIONS

1. PICTURE TUBE

Size	: 17 inch
Deflection Angle	: 90°
Neck Diameter	: 29.1 mm
Dot Pitch	: 0.28 mm
Face Treatment	: Anti-Glare
Diagonal Inch	: 16.06"

2. SIGNAL

2-1. Horizontal & Vertical Sync

- 1) Input Voltage Level : Low=0~1.2V, High=2.5~5.5V
- 2) Sync Polarity : Positive or Negative

2-2. Video Input Signal

- 1) Voltage Level : 0 ~ 0.7 Vp-p
 - a) Color 0, 0 : 0 Vp-p
 - b) Color 7, 0 : 0.467 Vp-p
 - c) Color 15, 0 : 0.7 Vp-p
- 2) Input Impedance : 75 Ω
- 3) Video Color : R, G, B Analog
- 4) Signal Format : Refer to the Timing Chart

2-3. Signal Connector

3 row 15-pin Connector (Attached)

2-4. Scanning Frequency

Horizontal	: 30 ~ 70 kHz
Vertical	: 50 ~ 140 Hz

3. POWER SUPPLY

3-1. Power Range

AC 100~240V , 50/60Hz, 2.0A

3-2. Power Consumption

MODE	POWER CONSUMPTION	LED COLOR
FULL POWER	less than 100 W	GREEN
STAND-BY	less than 5 W	AMBER
SUSPEND	less than 5 W	AMBER
POWER OFF	less than 5 W	OFF

4. DISPLAY AREA

4-1. Active Video Area :

- Max Image Size - 326.7 x 245.5 mm (12.86" x 9.67")
- Preset Image Size - 312 x 234 mm (12.28" x 9.21")

4-2. Display Color : Full Colors

4-3. Display Resolution : 1280 x 1024 / 60Hz
(Non-Interlace)

4-4. Video Bandwidth : 110 MHz

5. ENVIRONMENT

5-1. Operating Temperature: 10°C ~ 35°C (50°F ~ 95°F)
(Ambient)

5-2. Relative Humidity : 8%~ 80%
(Non-condensing)

5-3. Altitude : 5,000 m

6. DIMENSIONS (with TILT/SWIVEL)

Width	: 404.0 mm (15.90 inch)
Depth	: 438.5 mm (17.26 inch)
Height	: 426.0 mm (16.77 inch)

7. WEIGHT (with TILT/SWIVEL)

Net Weight	: 15.1 kg (33.29 lbs.)
Gross Weight	: 17.8 kg (39.24 lbs.)

SAFETY PRECAUTIONS

SAFETY-RELATED COMPONENT WARNING!

There are special components used in this color monitor which are important for safety. ***These parts are marked  on the schematic diagram and the replacement parts list.*** It is essential that these critical parts should be replaced with the manufacturer's specified parts to prevent X-radiation, shock, fire, or other hazards. Do not modify the original design without obtaining written permission from manufacturer or you will void the original parts and labor guarantee.

CAUTION: No modification of any circuit should be attempted.

Service work should be performed only after you are thoroughly familiar with all of the following safety checks and servicing guidelines.

SAFETY CHECK

Care should be taken while servicing this color monitor because of the high voltage used in the deflection circuits. These voltages are exposed in such areas as the associated flyback and yoke circuits.

FIRE & SHOCK HAZARD

An isolation transformer must be inserted between the color monitor and AC power line before servicing the chassis.

- In servicing, attention must be paid to the original lead dress specially in the high voltage circuit. If a short circuit is found, replace all parts which have been overheated as a result of the short circuit.
- All the protective devices must be reinstalled per the original design.
- Soldering must be inspected for the cold solder joints, frayed leads, damaged insulation, solder splashes, or the sharp points. Be sure to remove all foreign materials.

IMPLOSION PROTECTION

All used display tubes are equipped with an integral implosion protection system, but care should be taken to avoid damage and scratching during installation. Use only same type display tubes.

X-RADIATION

The only potential source of X-radiation is the picture tube. However, when the high voltage circuitry is operating properly there is no possibility of an X-radiation problem. The basic precaution which must be exercised is keep the high voltage at the factory recommended level; the normal high voltage is about 25.5kV. The following steps describe how to measure the high voltage and how to prevent X-radiation.

Note : It is important to use an accurate high voltage meter calibrated periodically.

- To measure the high voltage, use a high impedance high voltage meter, connect (-) to chassis and (+) to the CDT anode cap.
- Set the brightness control to maximum point at full white pattern.
- Measure the high voltage. The high voltage meter should be indicated at the factory recommended level.
- If the meter indication exceeds the maximum level, immediate service is required to prevent the possibility of premature component failure.
- To prevent X-radiation possibility, it is essential to use the specified picture tube.

CAUTION:

Please use only a plastic screwdriver to protect yourself from shock hazard during service operation.

TIMING CHART

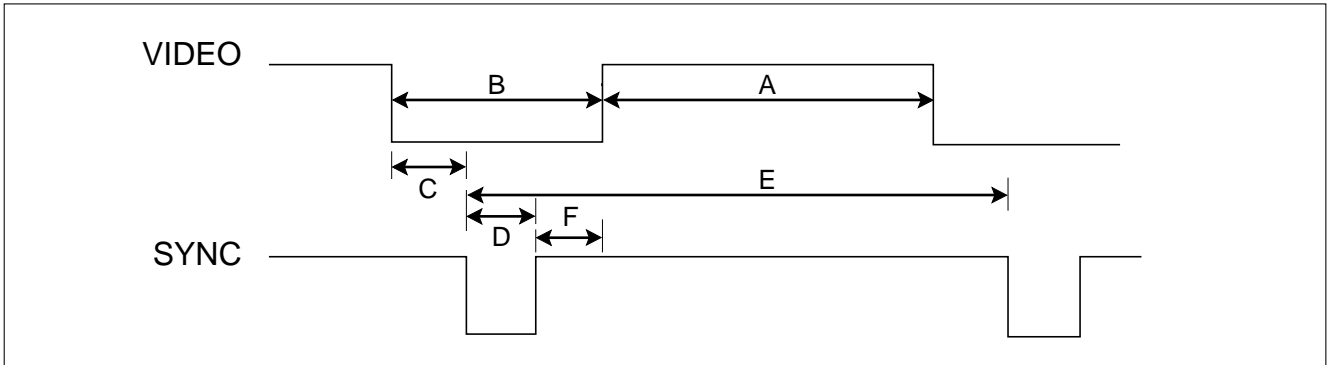

<< Dot Clock (MHz), Horizontal Frequency (kHz), Vertical Frequency (Hz), Horizontal etc... (μs), Vertical etc... (ms) >>

Mode	H/V Sort	Sync Polarity	Frequency	Total Period (E)	Video Active Time (A)	Blanking Time (B)	Sync Duration (D)	Back Porch (F)	Front Porch (C)	Resolution
1	H	-	37.500	26.667	20.317	6.349	2.032	3.810	0.508	640x480
	V	-	75.000	13.333	12.800	0.533	0.080	0.427	0.027	75Hz
2	H	-	31.469	31.778	25.422	6.356	3.813	1.907	0.636	640x480
	V	-	59.940	16.683	15.253	1.430	0.064	1.048	0.318	60Hz
3	H	-	43.269	23.112	17.778	5.334	1.556	2.222	1.556	640x480
	V	-	85.008	11.764	11.093	0.671	0.069	0.579	0.023	85Hz
4	H	-	31.470	31.778	25.422	6.356	3.813	1.907	0.636	720x400
	V	+	70.080	14.269	12.711	1.558	0.064	1.080	0.414	70Hz
5	H	+	46.880	21.330	16.160	5.170	1.620	3.230	0.320	800x600
	V	+	75.010	13.331	12.798	0.533	0.064	0.448	0.021	75Hz
6	H	+	53.674	18.631	14.222	4.409	1.138	2.702	0.569	800x600
	V	+	85.061	11.756	11.178	0.578	0.056	0.503	0.019	85Hz
7	H	+	60.023	16.660	13.003	3.657	1.219	2.235	0.203	1024x768
	V	+	75.029	13.328	12.795	0.533	0.050	0.466	0.017	75Hz
8	H	+	68.677	14.561	10.836	3.725	1.061	2.201	0.508	1024x768
	V	+	84.997	11.765	11.183	0.582	0.044	0.523	0.015	85Hz
9	H	+	63.98	15.63	11.85	3.78	1.04	2.30	0.44	1280x1024
	V	+	60.02	16.661	16.005	0.656	0.047	0.594	0.015	60Hz

OPERATING INSTRUCTIONS

FRONT VIEW

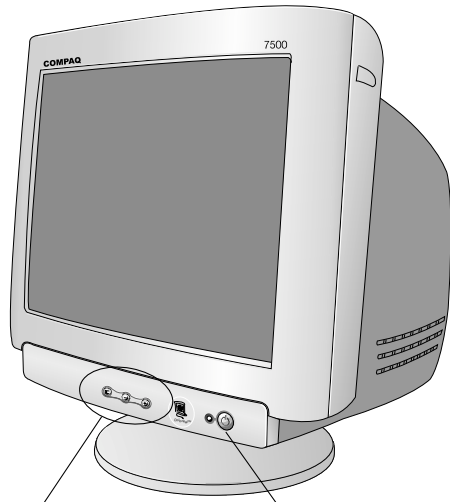

See Front Control Panel

Power ON/OFF Button

REAR VIEW

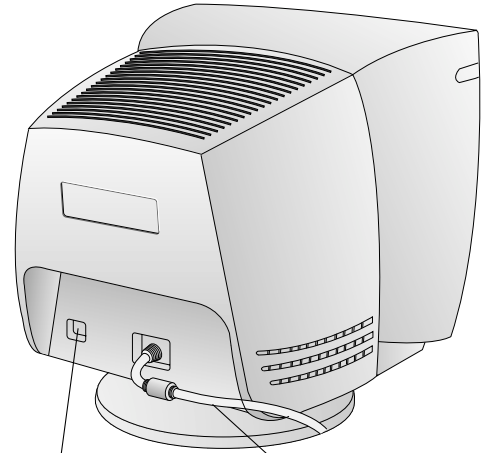

AC Power Socket

Signal Connector

Front Control Panel

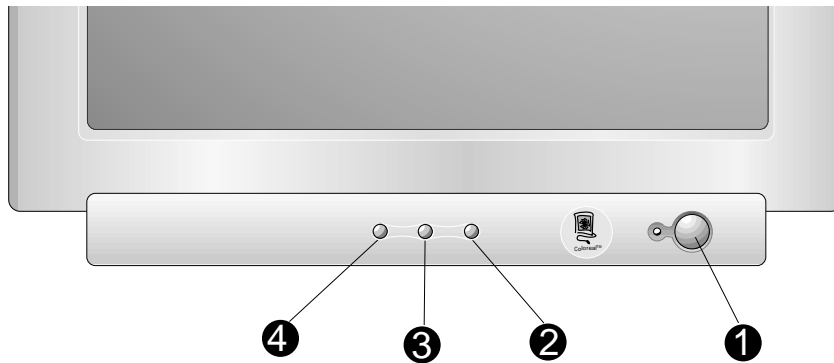

1.  **Power/LED**

Controls power to the monitor.
The LED on the power button is illuminated when the power is on.

2.  **Right Adjustment**

Moves clockwise through menu options or increases adjustment levels.

3.  **Left Adjustment**

Moves counter-clockwise through menu options or decreases adjustment levels.

4.  **Select**

Launches on-screen displays, selects functions and adjustments, and exits menus and On-Screen Display.

5. **Hot Key**

 **Left Adjustment**

Just select  left adjustment key without OSD display.
Contrast menu display.

 **Right adjustment**

Just select  right adjustment key with OSD display.
Brightness menu display.

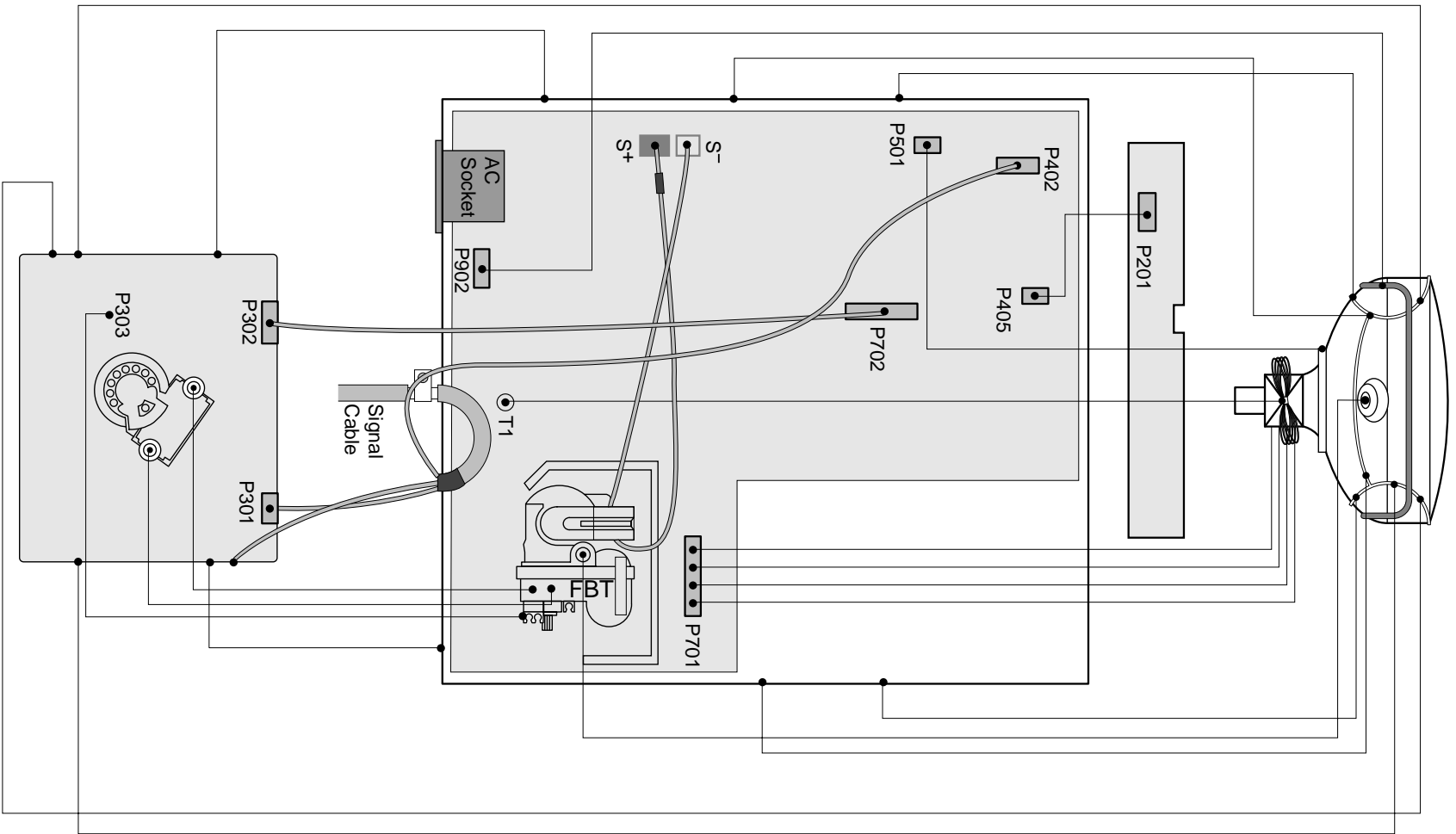

< OSD Control >



- CONTRAST
- BRIGHTNESS
- H POSITION
- H SIZE
- V POSITION
- V SIZE
- SPCC
- TRAPEZOID
- PIN BALANCE
- PARALLELOGRAM
- ROTATION
- DEGAUSS
- COLOR TEMPERATURE
- FACTORY RECALL
- EXIT

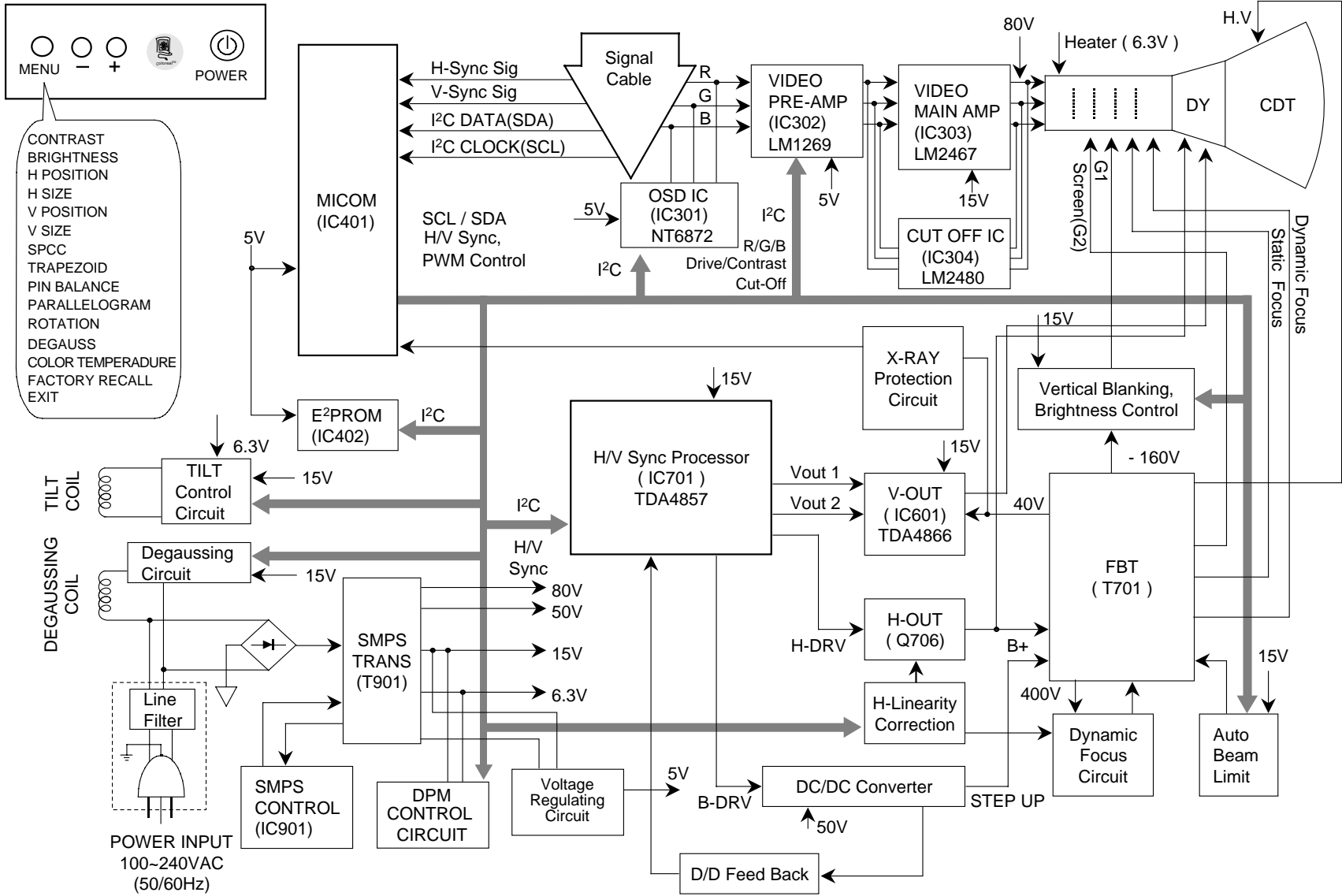

DESCRIPTION OF BLOCK DIAGRAM

1. Line Filter & Associated Circuit.

This is used for suppressing noise of power input line flowing into the monitor and/or some noise generated in this monitor flowing out through the power input line.

That is to say, this circuit prevents interference between the monitor and other electric appliances.

2. Degauss Circuit & Coil.

The degauss circuit consists of the degaussing coil, the PTC(Positive Temperature Coefficient) thermistor(TH901), and the relay(RL901). This circuit eliminates abnormal color of the screen automatically by degaussing the shadow mask in the CRT during turning on the power switch. When you need to degauss in using the monitor, select DEGAUSS on the OSD menu.

3. SMPS(Switching Mode Power Supply).

This circuit is working of 90~264V AC(50/60Hz).

The operation procedure is as follows:

- 1) AC input voltage is rectified and smoothed by the bridge diodes (D900) and the capacitor (C908).
- 2) The rectified voltage(DC) is applied to the primary coil of the transformer(T901).
- 3) The control IC(IC901) generates switching pulse to turn on and off the primary coil of the transformer (T901) repeatedly.
- 4) Depending on turn ratio of the transformer, the secondary voltages appear at the secondary coils of the transformer(T901).
- 5) These secondary voltages are rectified by each diode(D941, D942, D951, D961, D962, D971) and operate other circuit. (horizontal and vertical deflection, video amplifier, ...etc.)

4. Display Power Management Circuit.

This circuit control power consumption of the monitor by detecting H and V sync signal. There are off mode. When no horizontal or vertical sync signal input, the circuit consists of Q941 and Q951 becomes off mode. It's power consumption is below 5W.

5. X-ray Protection.

If the high voltage of the FBT reaches up to 29kV (abnormal state), IC401(MICOM) pin 35 Sensing from FBT directly. Then MICOM control IC701 (Deflection controller) to stop Horizontal drive pulse and stop Horizontal Deflection.

6. Micom(Microprocessor) Circuit.

The operating procedure of Micom(Microprocessor) and its associated circuit is as follows:

- 1) H and V sync signal is supplied from the signal cable.
- 2) The Micom(IC401) distinguishes polarity and frequency of H and V sync.

3) The Micom sets operating mode and offers the controlled data. (H-size, H-position, V-size, ... etc.)

4) The controlled data of each mode is stored in itself.

5) User can adjust screen condition by each OSD function. The data of the adjusted condition is stored in EEPROM(IC402).

7. Horizontal and Vertical Synchronous Processor.

This circuit generates the horizontal drive pulse and the vertical drive pulse by taking sync-signal from the Signal-Cable. This circuit consists of the TDA4857(IC701) and the associated circuit.

8. D/D(DC to DC) Converter.

This circuit supplies DC voltage to the horizontal deflection output circuit by increasing DC 50V which is the secondary voltage of the SMPS in accordance with the input horizontal sync signal.

9. Side-Pincushion & Trapezoid Correction Circuit.

This circuit improves the side-pincushion and the trapezoid distortion of the screen by mixing parabola and saw-tooth wave to output of the horizontal deflection D/D converter which is used for the supply voltage(B +) of the deflection circuit.

10. Horizontal Deflection Output Circuit.

This circuit makes the horizontal deflection by supplying the saw-tooth current to the horizontal deflection yoke.

11. High Voltage Output & FBT(Flyback Transformer).

The high voltage output circuit is used for generating pulse wave to the primary coil of the FBT(Flyback Transformer) . A boosted voltage(about 25.5KV) appears at the secondary of the FBT and it is supplied to the anode of the CDT. And there are another output voltages such as the dynamic focus and the screen voltage(G2).

12. H-Linearity Correction Circuit.

This circuit corrects the horizontal linearity for each horizontal sync frequency.

13. Vertical Output Circuit.

This circuit takes the vertical ramp wave from the TDA4857(IC701) and performs the vertical deflection by supplying the saw-tooth current from the TDA4866(IC601) to the vertical deflection yoke.

14. Dynamic Focus Output Circuit.

This circuit takes the horizontal and the vertical parabola waves from the TDA4857(IC701) and amplifies it to maintain constant focus on center and corners in the screen.

15. H & V Blanking and Brightness Control.

Blanking circuit eliminates retrace line by supplying negative pulse to the G1 of the CRT. And Brightness circuit is used for control of the screen brightness.

16. Image Rotation (Tilt) Circuit.

This circuit corrects the tilt of the screen by supplying the image rotation signal to the tilt coil which is attached near the deflection yoke of the CRT.

17. OSD Circuit

This circuit is used for performing the OSD(On-Screen-Display) function.

When a user selects the OSD Select/Adjustment control, the adjustment status displays on the screen.

18. Video Pre-Amp Circuit.

This circuit amplifies the analog video signal from 0-0.7V to 0-4V. It is operated by taking the clamp, R, G, B drive and contrast signal from the Micom(IC401).

19. Video Output Amp Circuit.

This circuit amplifies the video signal which comes from the video pre-amp circuit and amplified it to applied the CRT cathode.

ADJUSTMENT

GENERAL INFORMATION

All adjustment are thoroughly checked and corrected when the monitor leaves the factory, but sometimes several adjustments may be required.

Adjustment should be following procedure and after warming up for a minimum of 30 minutes.

- Alignment appliances and tools.
 - IBM compatible PC.
 - Programmable Signal Generator.
(eg. VG-819 made by Astrodesign Co.)
 - EPROM or EEPROM with saved each mode data.
 - Alignment Adaptor and Software.
 - Digital Voltmeter.
 - White Balance Meter.
 - Luminance Meter.
 - High-voltage Meter.

AUTOMATIC AND MANUAL DEGAUSSING

The degaussing coil is mounted around the CDT so that automatic degaussing when turn on the monitor. But a monitor is moved or faced in a different direction, become poor color purity cause of CDT magnetized, then press DEGAUSS on the OSD menu.

ADJUSTMENT PROCEDURE & METHOD

- Install the cable for adjustment such as Figure 1 and run the alignment program on the DOS for IBM compatible PC.
- Set external Brightness and Contrast volume to max position.

1. Adjustment for B⁺ Voltage.

- 1) Display cross hatch pattern at Mode 8.
- 2) Check C999 (+) voltage to 50 ± 0.5 Vdc.

2. Adjustment for High-Voltage.

- 1) Display cross hatch pattern at Mode 8.
- 2) DIST.ADJ → CTRL PWM → High Voltage Command.
- 3) Adjust High Voltage to $25.5\text{kV} \pm 0.3$ kVdc.
- 4) Press Enter Key.

3. Adjustment for Factory Mode (Preset Mode).

- 1) Display cross hatch pattern at Mode 1.
- 2) Run alignment program for CQ771G on the IBM compatible PC.
- 3) EEPROM → ALL CLEAR → Y(Yes) command.
<Caution> Do not run this procedure unless the EEPROM is changed. All data in EEPROM (mode data and color data) will be erased.
- 4) Power button of the monitor turn off → turn on.
- 5) COMMAND → PRESET START → Y(Yes) command.
- 6) DIST. ADJ. → CTRL PWM → TILT command.

- 7) Adjust tilt as arrow keys to be the best condition.
- 8) DIST. ADJ. → BALANCE command.
- 9) Adjust parallelogram as arrow keys to be the best condition.
- 10) Adjust balance of pin-balance as arrow keys to be the best condition.
- 11) DIST. ADJ. → FOS. ADJ command.
- 12) Adjust V-SIZE as arrow keys to 234 ± 2 mm.
- 13) Adjust V-POSITION as arrow keys to center of the screen.
- 14) Adjust H-SIZE as arrow keys to 312 ± 2 mm.
- 15) Adjust H-POSITION as arrow keys to center of the screen.
- 16) Adjust S-PCC (Side-Pincushion) as arrow keys to be the best condition.
- 17) Adjust TRAPEZOID as arrow keys to be the best condition.
- 18) Save of the Mode 1.
- 19) Display from Mode 1 to 8 and repeat above from number 12) to 19)
- 20) PRESET EXIT → Y (Yes) command.

4. Adjustment for White Balance and Luminance.

- 1) Set the White Balance Meter.
- 2) Press the DEGAUSS on the OSD menu for demagnetization of the CDT.
- 3) COLOR ADJ. → LUMINANCE command of the alignment program.
- 4) Set Brightness and Contrast to Max position.
- 5) Display color 0,0 pattern at Mode 8.
- 6) COLOR ADJ. → BIAS ADJ. → COLOR No. → 1 command of the alignment program.
- 7) Check whether green color or not at R-BIAS and G-BIAS to min position and B-BIAS to 127(7F) and Sub-Brightness to 177(B1) position. Adjust G2 (screen) command to 0.4 ± 0.05 FL of the raster luminance.
- 8) Adjust R-BIAS and G-BIAS command to $x=0.283 \pm 0.005$ and $y=0.298 \pm 0.005$ on the White Balance Meter with PC arrow keys.
- 9) Adjust SUB-Brightness command to 0.5 ± 0.1 FL of the raster luminance.
- 10) Adjust repeat number 8).
- 11) After push the "ENTER" key.
- 11-1) COMMAND → PRESET START → Y(Yes) command.
- 12) Display color 15,0 full white pattern at Mode 8.
- 13) DRIVE ADJ. → No 1. command.

- 14) Set Brightness is cut-off(0.06FL) and Contrast to Max position.
- 15) Set SUB-CONTRAST Max 127(7F) (decimal) position.
- 16) Set B-DRIVE to 90(5A); LG CDT at DRIVE of the alignment program. (TECO CDT: B-DRIVE 100(64))
- 17-1) Adjust R-DRIVE and G-DRIVE command to white balance $x=0.283\pm 0.003$ and $y=0.298\pm 0.003$ at Full-White on the White Balance Meter with PC arrow keys.
- 17-2) Display color 15,0 window pattern 5Box 50x50mm at mode 8.
- 18) Adjust SUB-CONTRAST command to 50 ± 1 FL at B/Raster 0.06FL.
- 19) Display color 15,0 full white patten at Mode 8.
- 20) Set Brightness and Contrast to Max position.
- 21) COLOR ADJ. → LUMINANCE → ABL command.
- 22) Adjust ABL to 33 ± 1 FL of the luminance at B/Raster 0.06FL.
- 23) After push the "ENTER" key, and "COMMAND → PRESET EXIT → Y(Yes)" command.
- 24) Exit from the program.

5. Input EDID Data.

- 1) Display color 15,0 cross hatch pattern at Mode 8.
- 2) EEPROM → Write EDID command and confirm "EDID Write OK!!" message of monitor.
- 3) Exit from the alignment program.
- 4) Power switch OFF/ON for EDID data save.

6. Adjustment for Focus.

- 1) Set the Brightness and Contrast to max position.
- 2) Display cross hatch with quadrant text pattern in full screen at Mode 8.
- 3) Adjust two Focus control on the FBT that focus should be the best condition.

TROUBLESHOOTING GUIDE

1. NO POWER

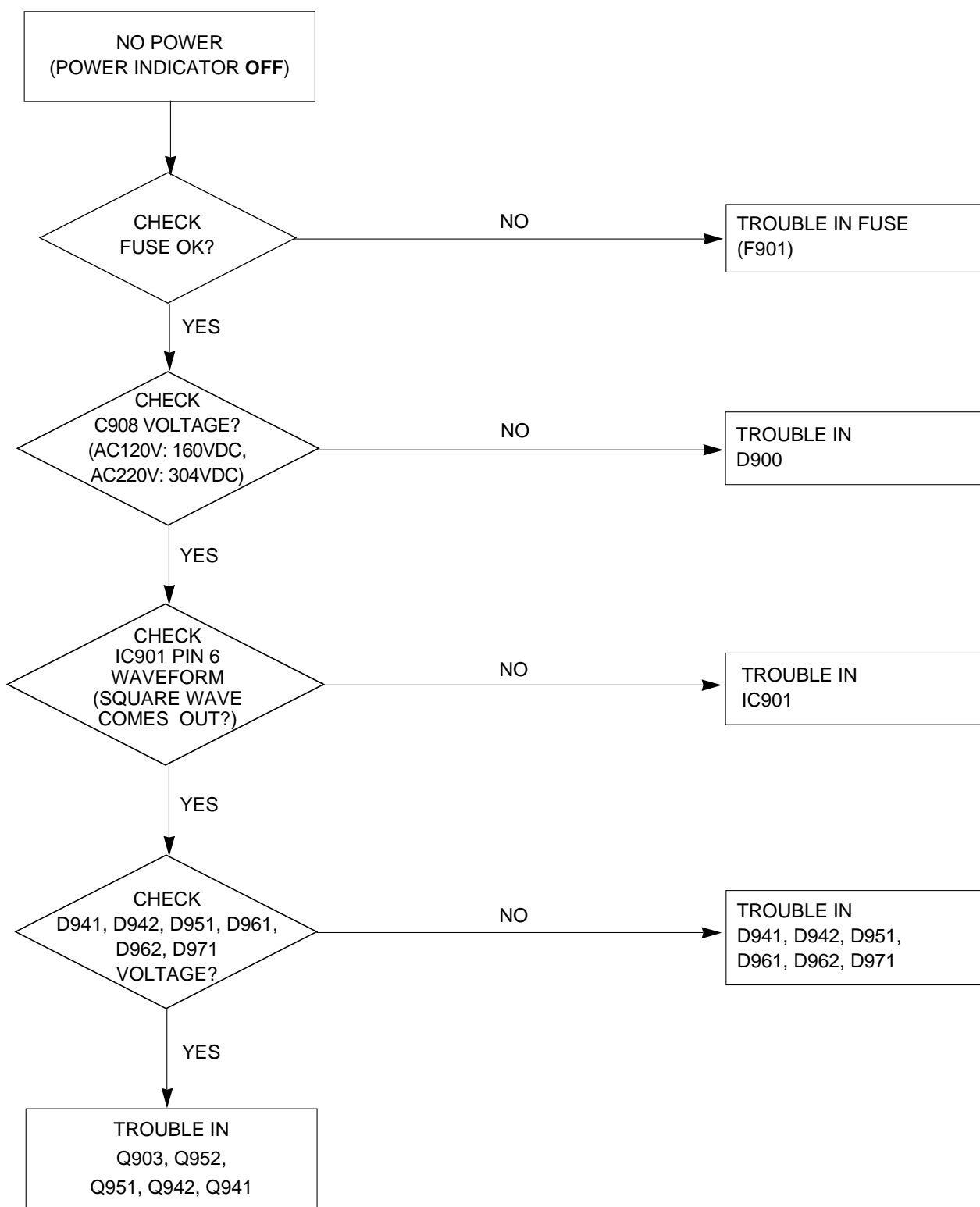

2. NO CHARACTER

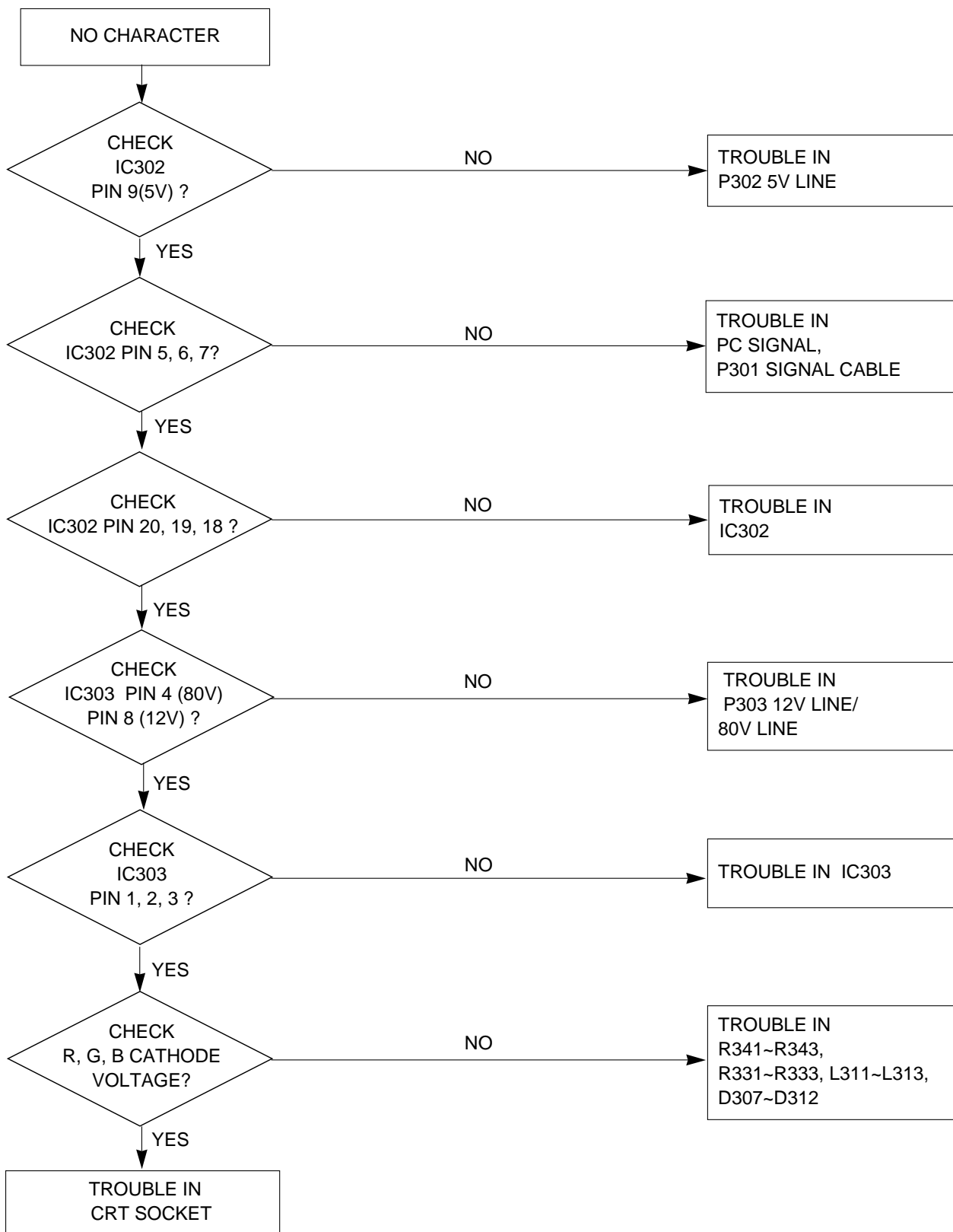

3. NO RASTER

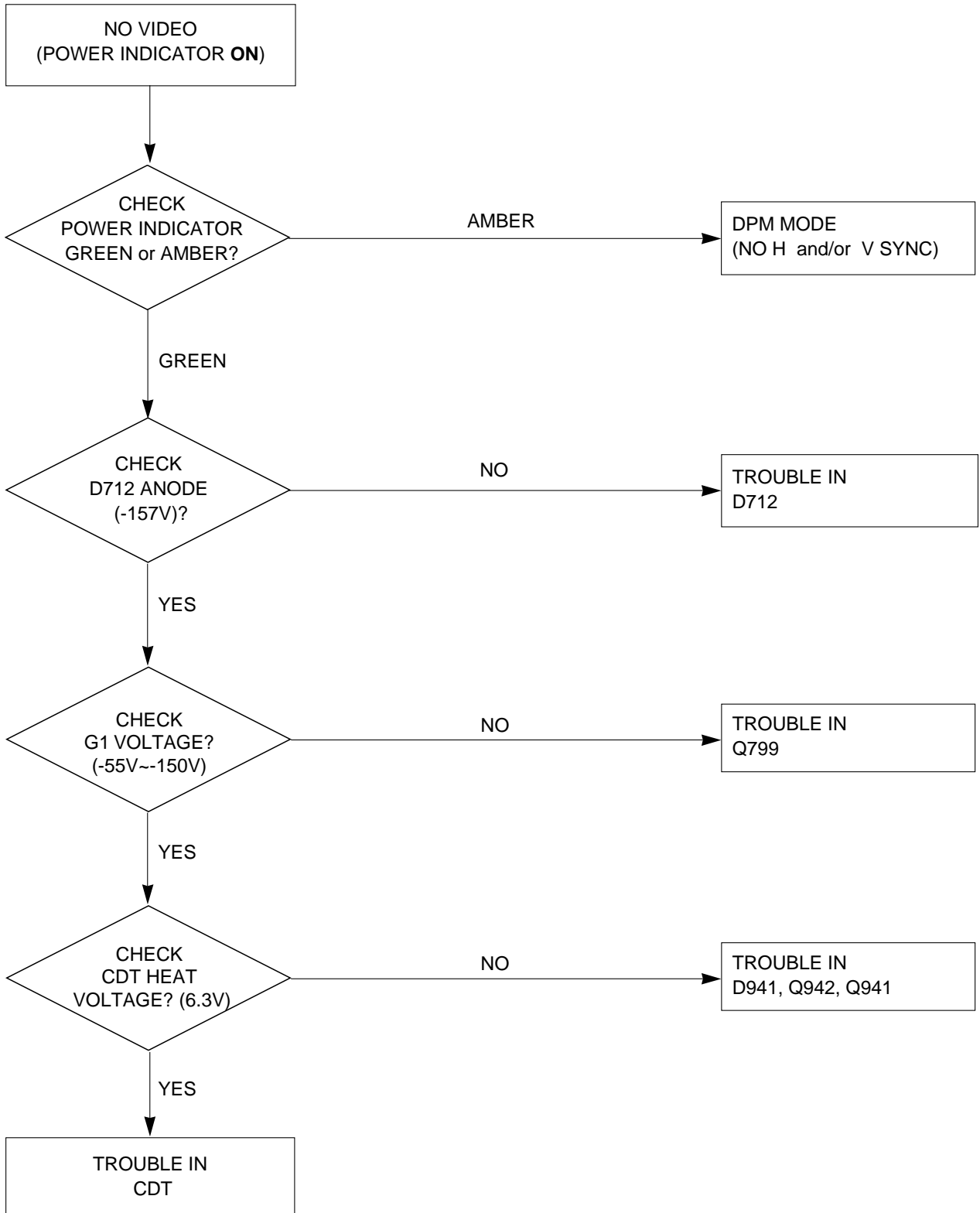

4. NO HORIZONTAL DEFLECTION

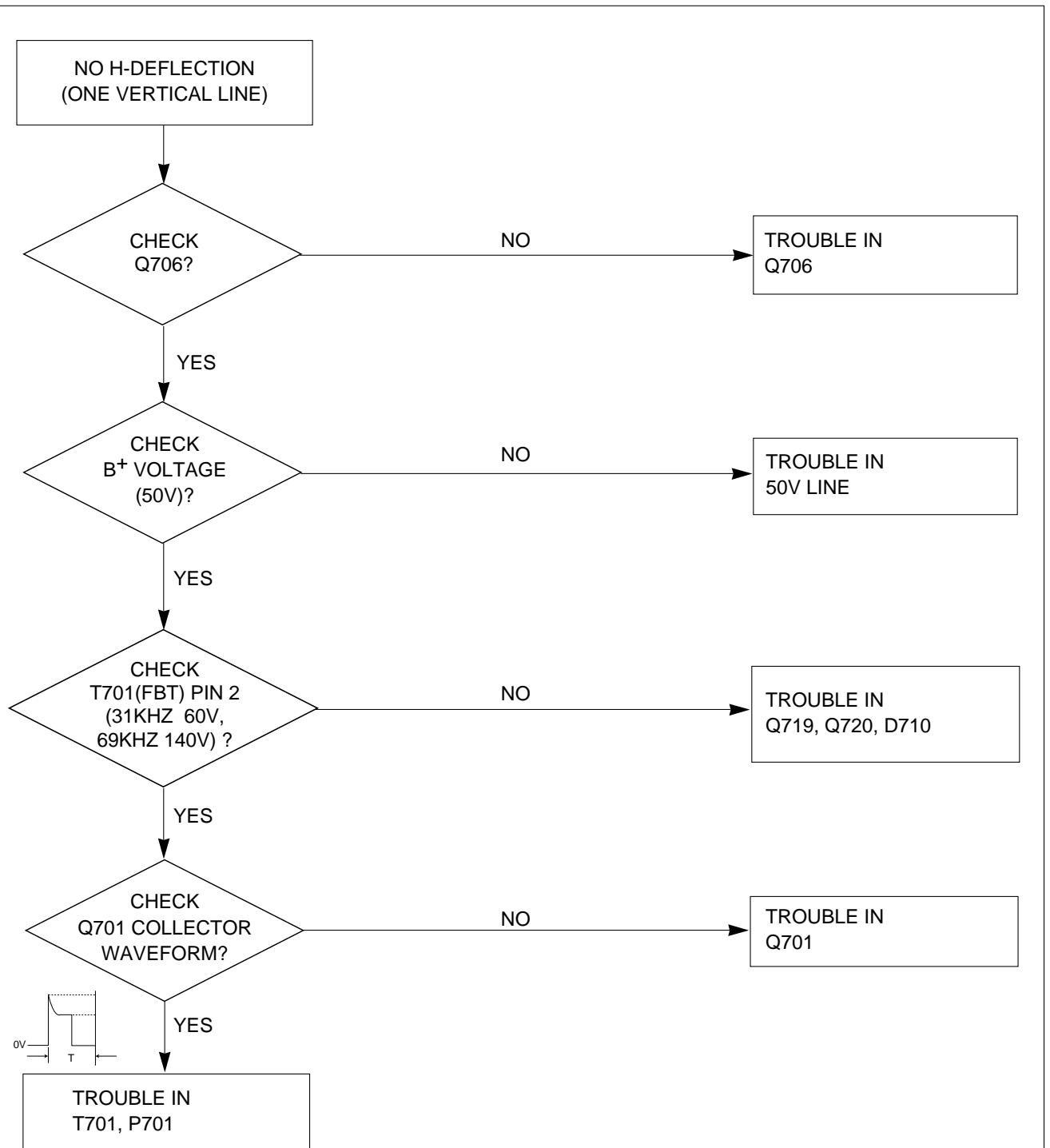

5. TROUBLE IN H-LINEARITY

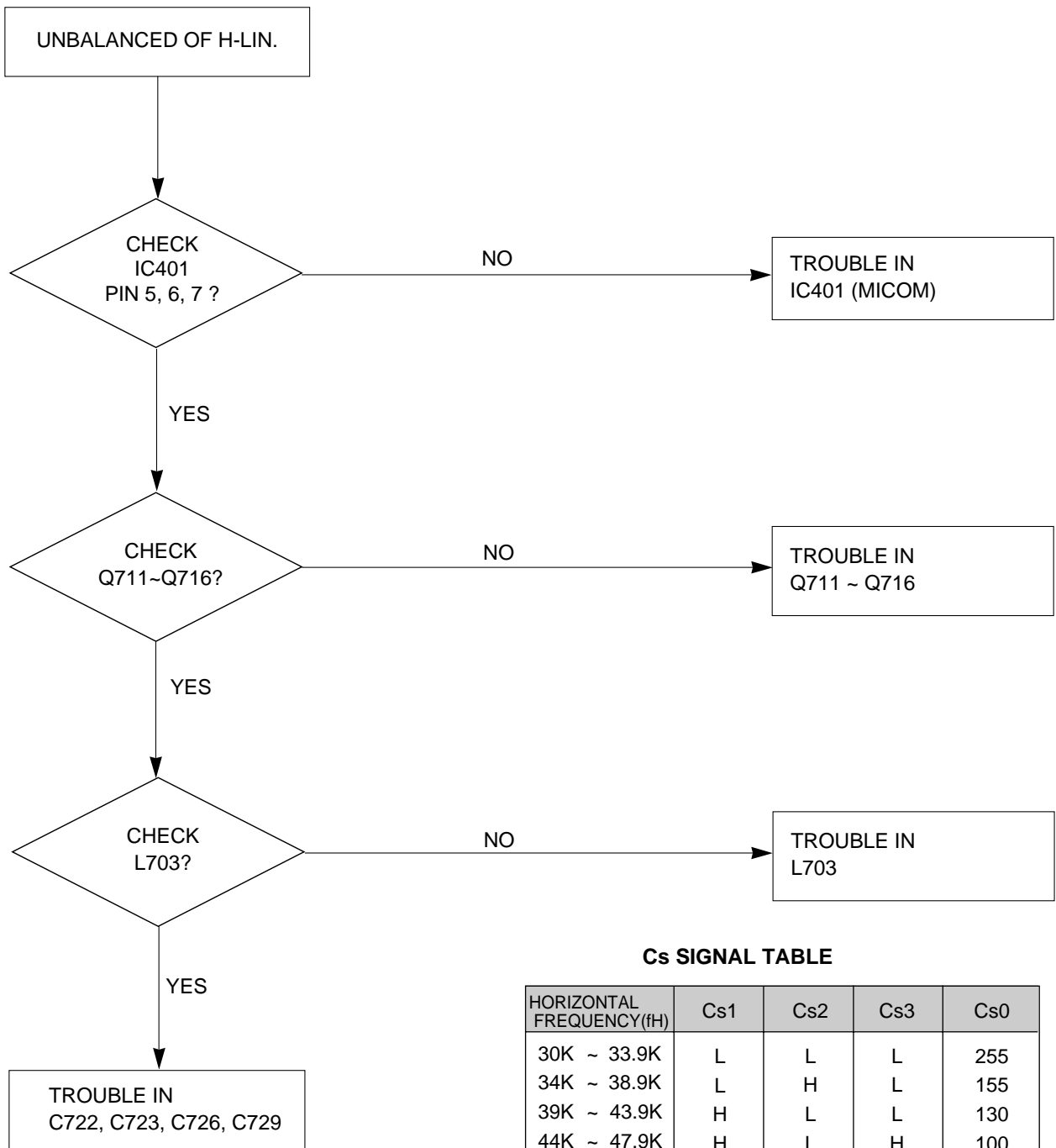

Cs SIGNAL TABLE

HORIZONTAL FREQUENCY(fH)	Cs1	Cs2	Cs3	Cs0
30K ~ 33.9K	L	L	L	255
34K ~ 38.9K	L	H	L	155
39K ~ 43.9K	H	L	L	130
44K ~ 47.9K	H	L	H	100
48K ~ 51.9K	H	L	H	85
52K ~ 57.9K	H	H	L	70
58K ~ 61.9K	H	H	L	60
62K ~ 65.9K	H	H	H	60
66K ~ 70K	H	H	H	30

6. NO VERTICAL DEFLECTION

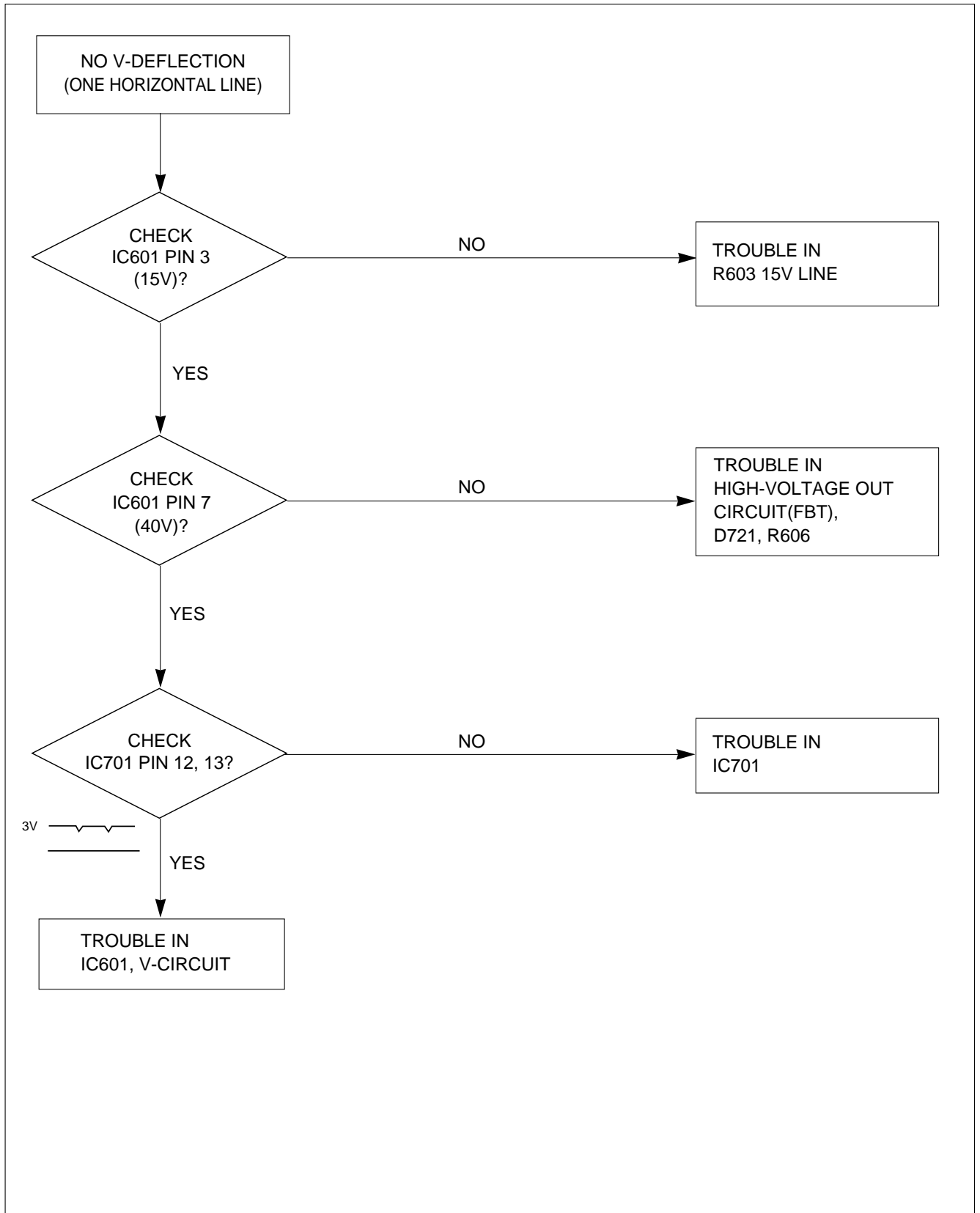

7. TROUBLE IN OSD

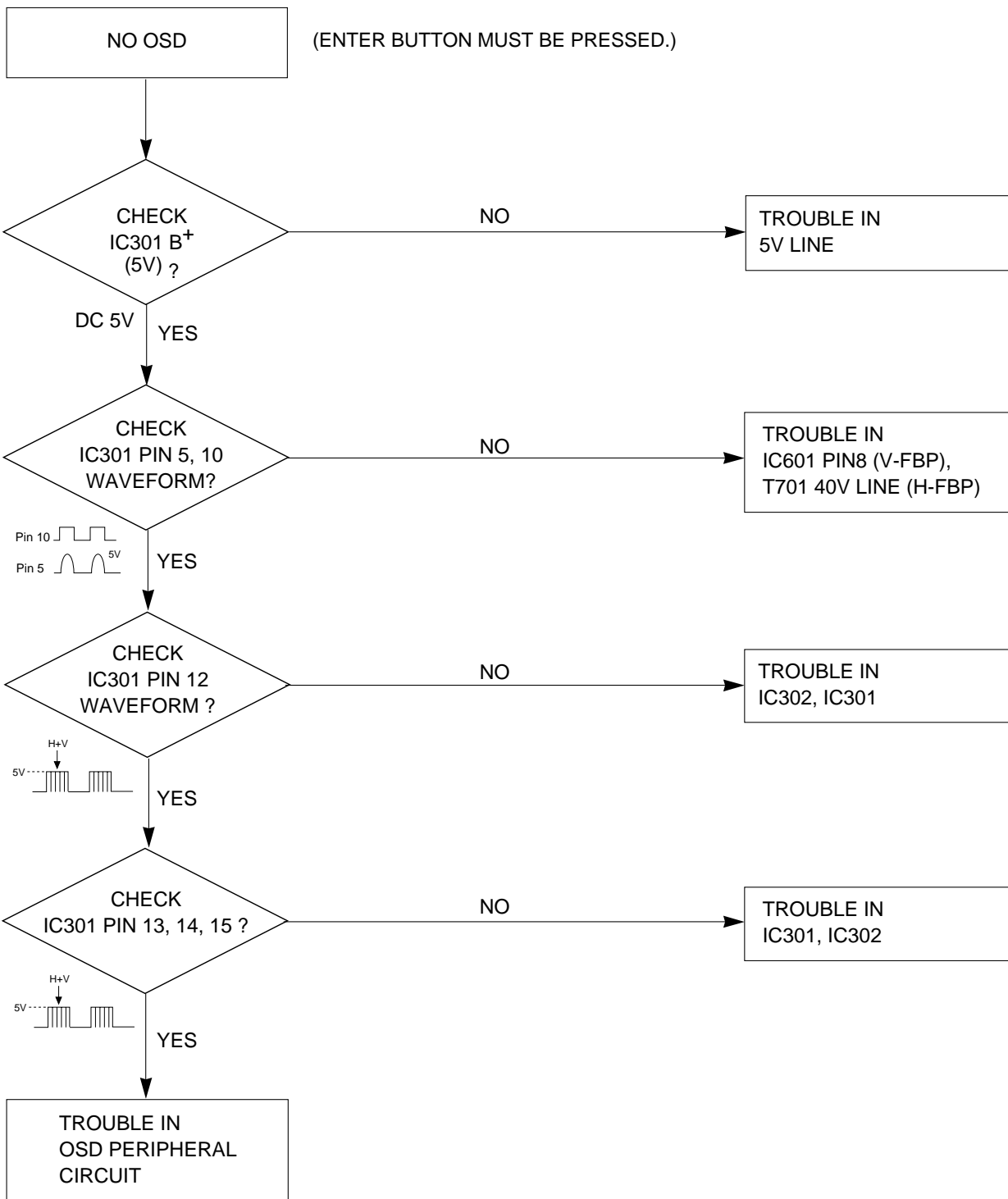

8. TROUBLE IN DPM

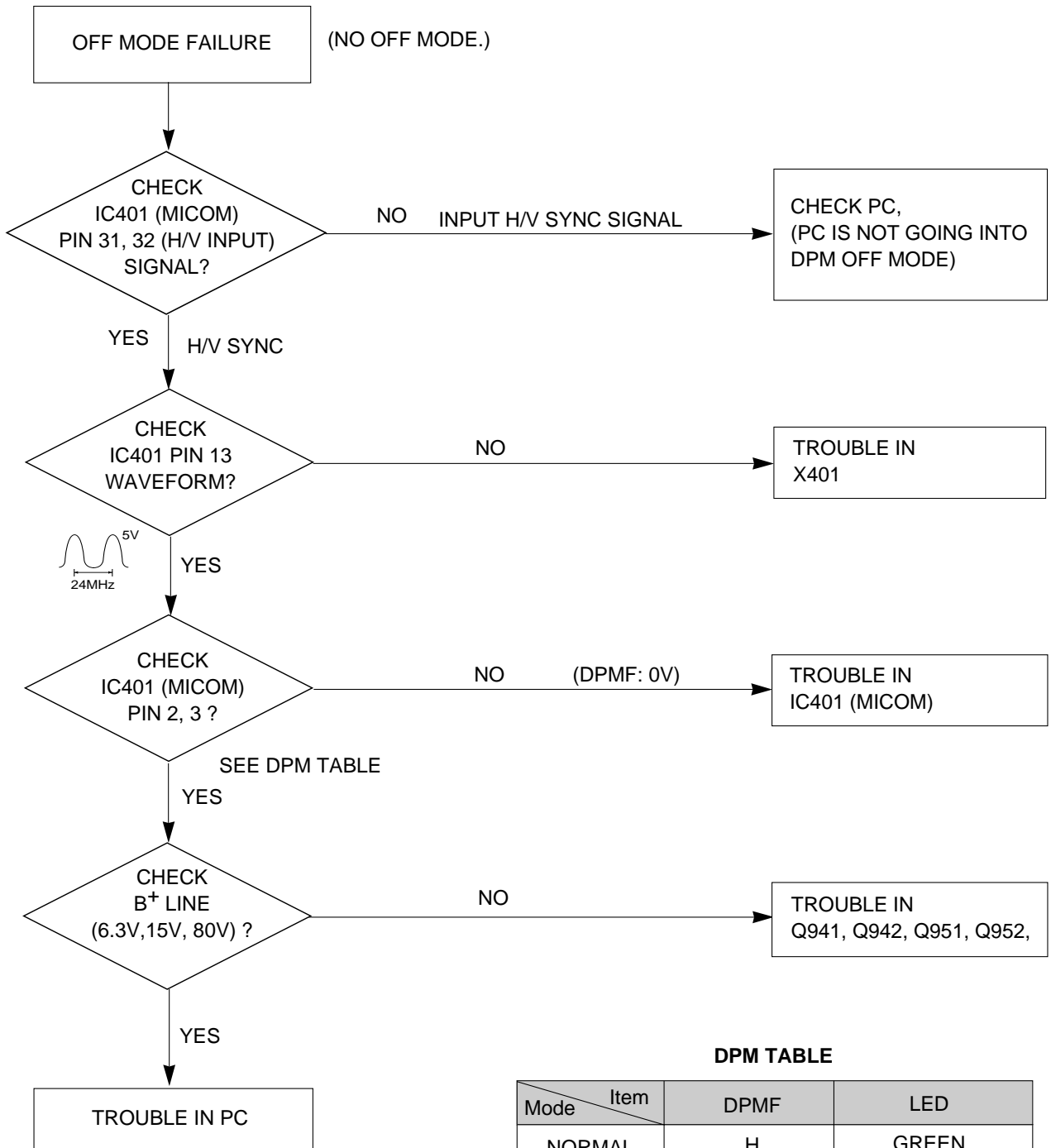

DPM TABLE

Mode \ Item	DPMF	LED
NORMAL	H	GREEN
STAND-BY	L	AMBER
SUSPEND	L	AMBER
OFF	L	AMBER

9. NO DEGAUSSING

(DEGAUSS ON THE OSD MENU MUST BE PRESSED.)

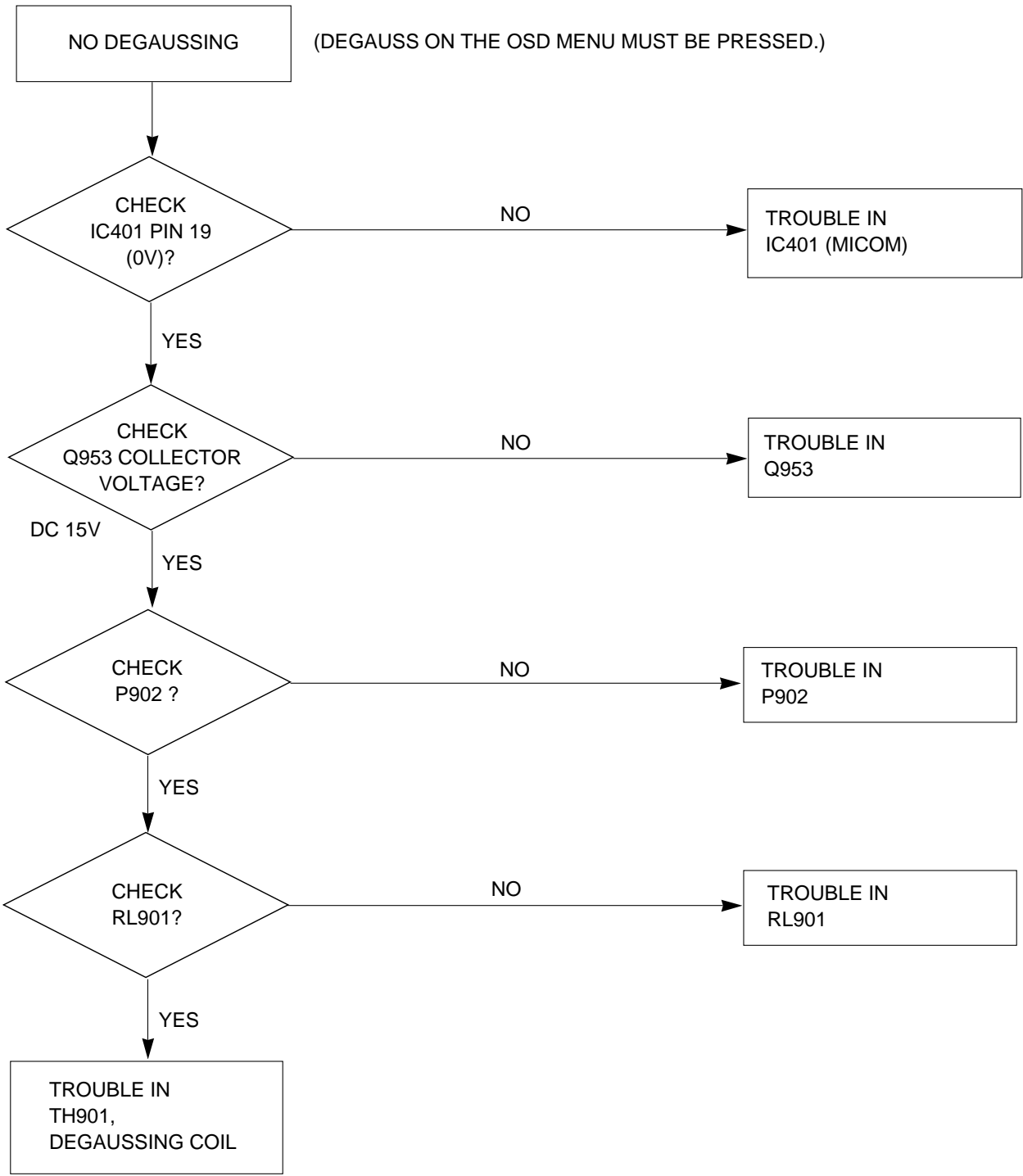

10. NO TILT (NO ROTATION)

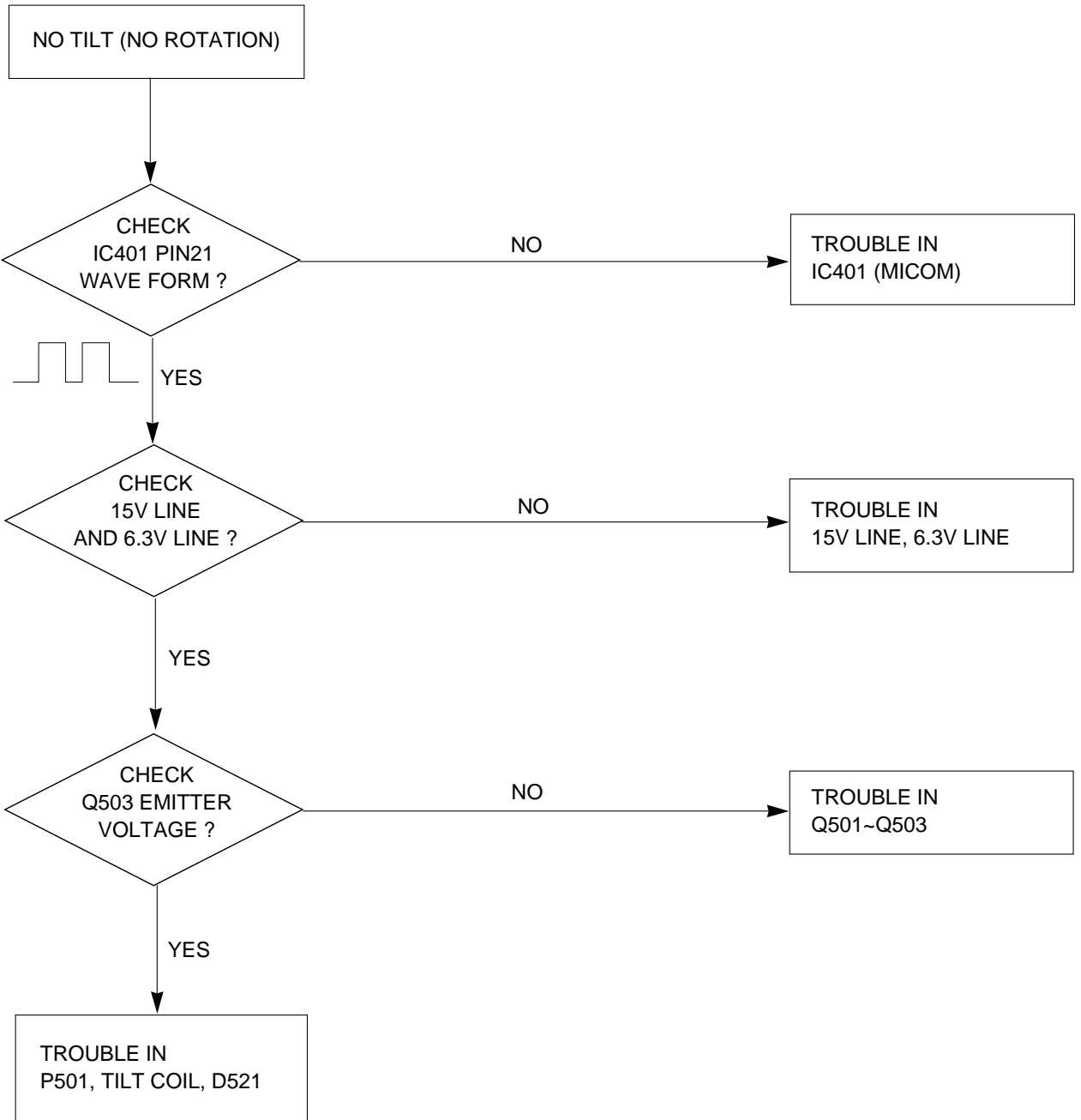

EXPLODED VIEW

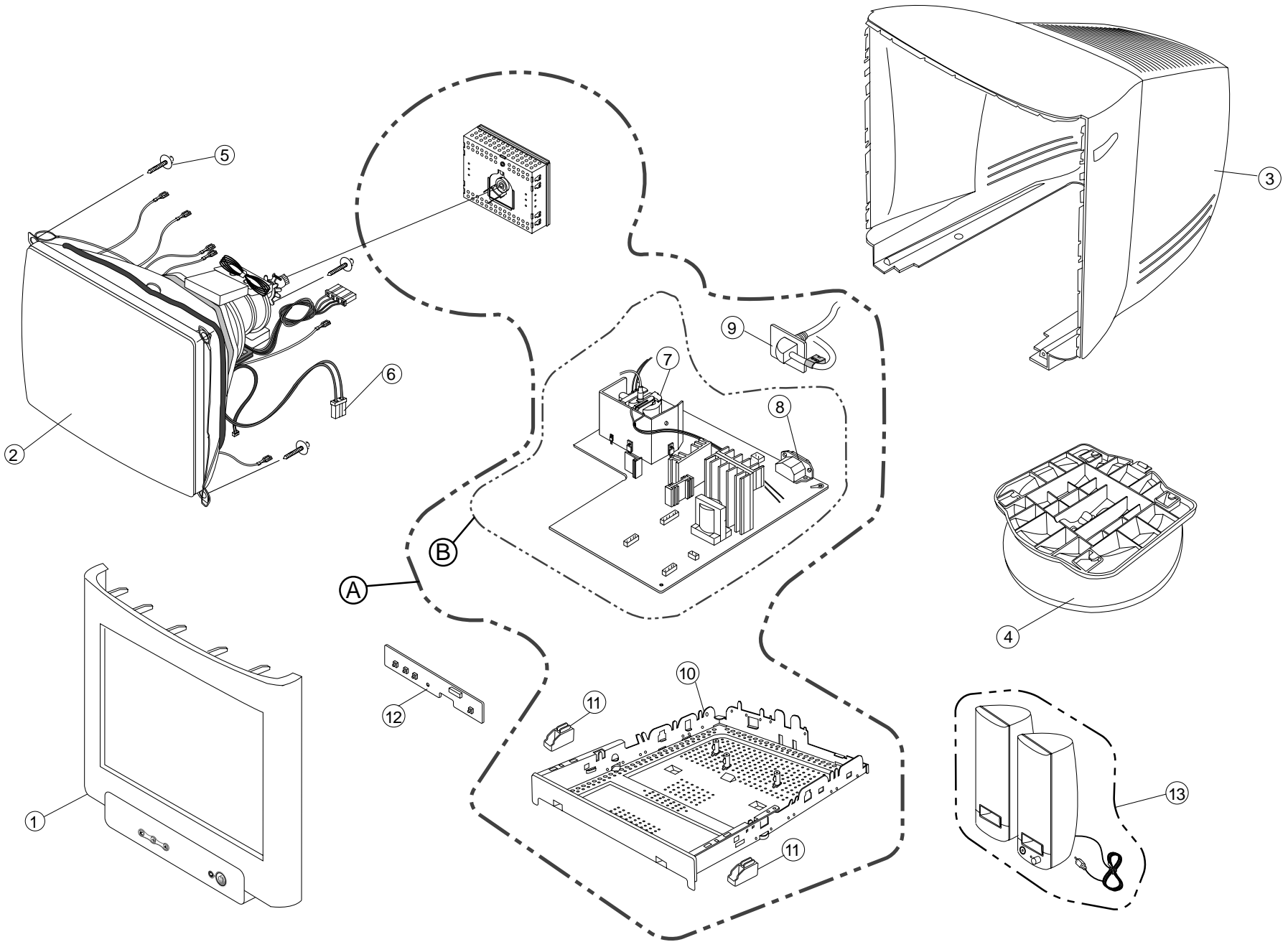

EXPLODED VIEW PARTS LIST

Ref. No.	Part No.	Description	
1	3091TKC078A	CABINET ASSEMBLY, CQ771G COMPAQ C072 TCO99 S7500 (PE1165T)	
	3091TKC078B	CABINET ASSEMBLY, CQ771G COMPAQ 072 MPR-II S7500(PE1165), CV7500(PE1165U), MV7500(PE1165U, PE1165)	
2	6318L17006A	CDT(CIRC), M41LFQ803X 55NLUUD LG-PHILIPS 70KHZ 29.1MM FST TCO S7500 (PE1165T); Northern Hemisphere	
	6318E17002A	CDT(CIRC), M41LRS102XX112 (Z) TECO 70KHZ 29.1MM FST MPR-II S7500 (PE1165); Northern Hemisphere	
	6318E17002B	CDT(CIRC), M41LRS102XX112 (EZ) TECO 70KHZ 29.1MM FST TCO S7500 (PE1165T); Northern Hemisphere	
	6318E17002C	CDT(CIRC), M41LRS102XX112 (NS)(Z) TECO 70KHZ 29.1MM CV7500, MV7500(PE1165U); Northern Hemisphere	
	6318E17002D	CDT(CIRC), M41LRS102XX112 (QZ) TECO 70KHZ 29.1MM FST MPR-II S7500 (PE1165); Equatorial	
	6318E17002E	CDT(CIRC), M41LRS102XX112 (NS)(QZ) TECO 70KHZ 29.1MM FST- MV7500(PE1165U); Equatorial	
	6318E17002F	CDT(CIRC), M41LRS102XX112 (SZ) TECO 70KHZ 29.1MM FST MPR-II MV7500, S7500(PE1165); Southern Hemisphere	
	6318L17005A	CDT(CIRC), M41LFQ803X55NLAA LG-PHILIPS 70KHZ 29.1MM FST MPR-II S7500(PE1165); Northern Hemisphere	
	6318L17005B	CDT(CIRC), M41LFQ803X 55QLAA LG-PHILIPS 70KHZ 29.1MM FST MPR-II S7500(PE1165); Equatorial	
	6318L17005C	CDT(CIRC), M41LFQ803X 55SLAA LG-PHILIPS 70KHZ 29.1MM FST MPR-II S7500, MV7500(PE1165); Southern Hemisphere	
	6318L17007A	CDT(CIRC), M41LFQ503X 55NLLD LG-PHILIPS 70KHZ 29.1MM FST CV7500, MV7500(PE1165U); Northern Hemisphere	
	6318L17007B	CDT(CIRC), M41LFQ503X 55QLLD LG-PHILIPS 70KHZ 29.1MM FST MV7500(PE1165U);Equatorial	
	3	3809TKC044A	BACK COVER ASSEMBLY, CQ771G C043 TCO99 COMPAQ S7500 (PE1165T)
		3809TKC044B	BACK COVER ASSEMBLY, CQ771G C043 MPR-II COMPAQ S7500(PE1165), CV7500(PE1165U), MV7500(PE1165U, PE1165)
4	3043TKK093C	TILT SWIVEL ASSEMBLY, CQ771G T062 B054 HF350U	
5	339-002K	SCREW ASSEMBLY, TAPTITE P TYPE D5.0 L25.0 MSWR/FZMY	
6	6140TC3004A	COIL,DEGAUSSING, 1090MM 16.5OHM 0.4MM 110T 17" WITH EARTH	
7	6174T11003E	FBT (FLY BACK TRANSFORMER), 1054A,CB777G LG-PHILIPS 17" T701	
8	6620TKB002B	SOCKET(CIRC),POWER, SA-4S HUA JIE AC UNIVERSAL 3PIN BLACK SC901	
9	6850TA9004C	CABLE,D-SUB, UL 2990-9C(7.5) AT 1870MM COMPAQ BK EQ770G DM	
10	4950TKS196A	METAL, FRAME BOTTOM CQ77XG	
11	4810TKK195A	BRACKET, CQ77XG SUPPORTER CDT	
12	6871TST292B	PWB(PCB) ASSEMBLY,SUB, CQ771G(NT) CONTROL TOTAL COMPAQ CA-110	
13	6401TZZ022B	SPEAKER ASSEMBLY, CQ771G FOR COMPAQ(259139-001) SPK ASSY(L/R) BLACK MV7500(PE1165U)	
A	3313T17258B	MAIN TOTAL ASSEMBLY, CQ771G(NT,LG) COMPAQ CA-110 LG-PHILIPS CDT	
	3313T17258D	MAIN TOTAL ASSEMBLY, CQ771G(NT,TECO) COMPAQ CA-110 TECO CDT	
B	6871TMT300B	PWB(PCB) ASSEMBLY,MAIN, CQ771G(NT) KXLGMT(LG) COMPAQ CA-110 TOTAL LG-PHILIPS CDT	
	6871TMT300D	PWB(PCB) ASSEMBLY,MAIN, CQ771G(NT) KXLBNT(TECO) COMPAQ CA-110 TOTAL TECO CDT	

REPLACEMENT PARTS LIST



CAUTION: BEFORE REPLACING ANY OF THESE COMPONENTS,
READ CAREFULLY THE **SAFETY PRECAUTIONS** IN THIS MANUAL.

* NOTE : **S** SAFETY Mark 
AL ALTERNATIVE PARTS

DATE: 2002. 04. 15.

*S	*AL	LOC. NO.	PART NO.	DESCRIPTION / SPECIFICATION
CAPACITORS				
		C201	OCN1040K949	0.1M 50V Z F TA52
		C301	181-288N	MKT 100V 103JTR PHS86103
		C302	OCE107CF638	100UF SHL,SD 16V M FM5 TP 5
		C303	OCK1040K945	0.1UF 50V Z F TR
		C304	181-288N	MKT 100V 103JTR PHS86103
		C305	OCE107CF638	100UF SHL,SD 16V M FM5 TP 5
		C306	181-288N	MKT 100V 103JTR PHS86103
		C307	OCN5610K519	560P 50V K B TA52
		C308	OCN1040K949	0.1M 50V Z F TA52
		C309	OCK1040K945	0.1UF 50V Z F TR
		C310	181-288B	MKT 100V 104JTR PHS26104
		C311	OCK1040K945	0.1UF 50V Z F TR
		C312	OCN1040K949	0.1M 50V Z F TA52
		C313	OCK1040K945	0.1UF 50V Z F TR
		C314	OCC4700W405	47PF 500V J SL TP
		C315	OCE476CF638	47UF SHL,SD 16V M FM5 TP 5
		C316	OCK1010W515	100P 500V K B TS LPD CDT
		C316	OCK1020W515	1000P 500V K B TS TECO CDT
		C317	OCN1040K949	0.1M 50V Z F TA52
		C318	OCK1040K945	0.1UF 50V Z F TR
		C319	OCN1040K949	0.1M 50V Z F TA52
		C320	OCK1040K945	0.1UF 50V Z F TR
		C321	OCE475CK638	4.7UF SHL,SD 50V M FM5 TP 5
		C322	OCN6810K519	680P 50V K B TA52
		C323	OCE476CF638	47UF SHL,SD 16V M FM5 TP 5
		C324	OCK1040K945	0.1UF 50V Z F TR
		C325	181-288D	MKT 100V 473JTR PHS26473
		C326	OCE106CN638	10UF SHL,SD 100V M FM5 TP 5
		C327	181-288B	MKT 100V 104JTR PHS26104
		C328	OCE106CN638	10UF SHL,SD 100V M FM5 TP 5
		C329	181-288B	MKT 100V 104JTR PHS26104
		C330	181-288B	MKT 100V 104JTR PHS26104
		C331	181-288G	MKT 100V 334JTR PHS26334
		C332	181-288G	MKT 100V 334JTR PHS26334
		C333	181-288G	MKT 100V 334JTR PHS26334
		C334	181-288B	MKT 100V 104JTR PHS26104
		C335	181-288B	MKT 100V 104JTR PHS26104
		C336	181-288E	MKT 100V 474JTR PHS 26474
		C337	OCK5610K515	560P 50V K B TS
		C338	OCK10302940	0.01M 2KV Z F S
		C339	OCK4710W515	470P 500V K B TS
		C340	OCK1040K945	0.1UF 50V Z F TR
		C341	OCK10302940	0.01M 2KV Z F S
		C342	OCE106CK638	10UF SHL,SD 50V M FM5 TP 5
		C343	OCC1000W105	10PF 500V D SL TR
		C346	OCK10302940	0.01M 2KV Z F S
		C351	OCC0400K115	4P 50V D NP0 TS
		C352	OCC0400K115	4P 50V D NP0 TS
		C353	OCC0400K115	4P 50V D NP0 TS
		C354	OCC0400K115	4P 50V D NP0 TS
		C355	OCC0400K115	4P 50V D NP0 TS
		C356	OCC0400K115	4P 50V D NP0 TS
		C358	OCK8210K515	820P 50V K B TS

DATE: 2002. 04. 15.

*S	*AL	LOC. NO.	PART NO.	DESCRIPTION / SPECIFICATION
		C372	OCK1040K945	0.1UF 50V Z F TR
		C401	OCN1040K949	0.1M 50V Z F TA52
		C402	OCE476CF638	47UF SHL,SD 16V M FM5 TP 5
		C403	OCK1040K945	0.1UF 50V Z F TR
		C404	OCC1800K415	18P 50V J NP0 TP
		C405	OCC1800K415	18P 50V J NP0 TP
		C406	OCK1010K515	100PF 50V K B TR
		C407	OCK1010K515	100PF 50V K B TR
		C408	OCK1040K945	0.1UF 50V Z F TR
		C409	OCC5600K415	56P 50V J NP0 TP
		C410	OCK1010K515	100PF 50V K B TR
		C411	OCK1040K945	0.1UF 50V Z F TR
		C412	OCK1040K945	0.1UF 50V Z F TR
		C413	OCK1040K945	0.1UF 50V Z F TR
		C414	OCK1040K945	0.1UF 50V Z F TR
		C501	OCE106CF638	10UF SHL,SD 16V M FM5 TP 5
		C599	OCE225CK638	2.2UF SHL,SD 50V M FM5 TP 5
		C601	OCE477EH618	470UF KMG 25V M FL TP 5
		C602	181-288B	MKT 100V 104JTR PHS26104
		C603	OCE476CK638	47UF SHL,SD 50V M FM5 TP 5
		C604	181-288T	MKT 100V 223KTR PHS85223
		C605	OCK1020W515	1000P 500V K B TS
		C701	OCQ5621N419	5600P 100V J POLY NI TP
		C702	OCZZTFT001M	ECQB1H103JM3 103J 50V TP5.0 MA
		C703	OCZZTFT001Z	ECQB1H104JM3 104J 50V TP5.0 MA
		C704	OCQ8221N519	0.0082U 100V K POLY NI TP
		C705	OCE476CF638	47UF SHL,SD 16V M FM5 TP 5
		C706	OCZZTFT001Z	ECQB1H104JM3 104J 50V TP5.0 MA
		C707	OCZZTFT002B	ECQV1H154JZ3 154J 50V TP5.0 MA
		C708	OCE227CH638	220UF SHL,SD 25V M FM5 TP 5
		C709	181-288P	MKT 100V 153JTR PHS86153
		C710	OCK1040K945	0.1UF 50V Z F TR
		C711	OCQ5621N419	5600P 100V J POLY NI TP
		C712	OCE475CK638	4.7UF SHL,SD 50V M FM5 TP 5
		C713	OCQ1031N419	0.01U 100V J POLY NI TP
		C716	OCK2710K515	270P 50V K B TS
		C717	OCE105CN638	1UF SHL,SD 100V M FM5 TP 5
		C718	181-288D	MKT 100V 473JTR PHS26473
		C719	OCZZTBA001A	SM-BP(P)/BP 10UF 50V 13*25 BK5
		C720	OCK22101515	220P 1KV K B TP5
		C721	181-477M	822J 19.5*12.0*7.0*7.5 250V J
		C722	181-303G	334J 31.0*22.0*15.0*20.0 250V
		C723	181-305C	154J 19.0*14.0*8.0*10.0 250V J LPD CDT
		C723	181-305E	MPP 250V 224J S=10.0 TECO CDT
		C724	OCN1040K949	0.1M 50V Z F TA52
		C726	181-482H	364J 18.0*19.0*12.0*7.5 250V J
		C727	OCN1040K949	0.1M 50V Z F TA52
		C728	OCQ5621N419	5600P 100V J POLY NI TP
		C729	181-305L	684J 26.0*19.0*12.5*15.0 250V
		C730	OCN1040K949	0.1M 50V Z F TA52
		C731	OCBZTBU004H	5600PF D 2.5KV H M/PP NI FM20 LPD CDT
		C731	OCBZTBU004G	622J 29.0*21.0*10.0*20.0 2.5KV TECO CDT
		C732	OCQ1031N419	0.01U 100V J POLY NI TP
		C733	OCBZTBU003H	362J 20.0*12.0*7.0*10.0 800V J

DATE: 2002. 04. 15.				
*S	*AL	LOC. NO.	PART NO.	DESCRIPTION / SPECIFICATION
		C737	OCKZTTA002N	100PF K 2KV R TP5.0
		C738	OCKZTTA003D	SC SAMWHA 250V 1000F M TAPING
		C739	OCE226CK638	22UF SHL,SD 50V M FM5 TP 5
		C740	OCE227EL630	220UF KMG 63V M FM5 BULK
		C741	0CZZTFT002B	ECQV1H154JZ3 154J 50V TP5.0 MA
		C742	0CZZTFT001R	ECQB1H223JM3 223J 50V TP5.0 MA
		C743	OCK3310W515	330P 500V K B TS
		C744	OCE107CP630	100UF SHL 160V M FM5 BULK
		C745	OCK5610W515	560P 500V K B TS
		C746	OCK33101515	330P 1KV K B TS
		C747	OCK3320W515	3300P 500V K B TS
		C748	0CZZTFT002B	ECQV1H154JZ3 154J 50V TP5.0 MA
		C749	OCE2256R638	2.2000UF SMS 250V M FM5 TP5
		C750	OCK1040K945	0.1UF 50V Z F TR
		C751	181-288N	MKT 100V 103JTR PHS86103
		C752	0CQ4721N419	0.0047U 100V J POLY NI TP5
		C754	OCC4700W405	47PF 500V J SL TP
		C755	181-288B	MKT 100V 104JTR PHS26104
		C767	OCK10301510	0.01M 1KV K B S
		C771	OCK10301510	0.01M 1KV K B S
		C773	OCE107CH638	100UF SHL,SD 25V M FM5 TP 5
		C774	181-288B	MKT 100V 104JTR PHS26104
		C775	OCK2210K515	220P 50V K B TS
		C781	OCK1030K945	0.01UF 50V Z F TR
		C801	OCK1040K945	0.1UF 50V Z F TR
		C802	OCE106CK638	10UF SHL,SD 50V M FM5 TP 5
		C805	OCE106CK638	10UF SHL,SD 50V M FM5 TP 5
		C810	OCE106CK638	10UF SHL,SD 50V M FM5 TP 5
		C821	OCK1040K945	0.1UF 50V Z F TR
		C822	OCN1040K949	0.1M 50V Z F TA52
		C901	0CBZTBU002B	BULK PCX2 335 474K
		C902	0CBZTBU002A	BULK PCX2 335 224K
		C903	OCKZTTA003A	SC E 222M 10.0FF7 250V TP7.5 S
		C904	OCKZTTA003A	SC E 222M 10.0FF7 250V TP7.5 S
		C905	OCE476EK638	47UF KMG 50V M FM5 TP 5
		C906	OCK3320K515	3300P 50V K B TS
		C908	181-124R	220UF SMG(25.4*40) 400V M VNSN
		C909	181-304T	273J 19.5*14.0*8.5*10.0 400V J
		C910	OCK33101515	330P 1KV K B TS
		C911	0CQ1021N419	1000P 100V J POLY NI TP
		C912	OCKZTTA003D	SC SAMWHA 250V 1000F M TAPING
		C913	OCKZTTA003D	SC SAMWHA 250V 1000F M TAPING
		C914	OCKZTBU003C	SC E 472M 14.0BW7 250V BK7.5 S
		C914	OCKZTBU003C	SC E 472M 14.0BW7 250V BK7.5 S
		C915	OCKZTBU003C	SC E 472M 14.0BW7 250V BK7.5 S
		C915	OCKZTBU003C	SC E 472M 14.0BW7 250V BK7.5 S
		C941	OCE108EF630	1000UF KMG 16V M FM5 BULK
		C942	OCE107CF638	100UF SHL,SD 16V M FM5 TP 5
		C943	OCKZTTA002A	220PF K 1KV R TP5.0
		C944	OCKZTBU003C	SC E 472M 14.0BW7 250V BK7.5 S
		C944	OCKZTBU003C	SC E 472M 14.0BW7 250V BK7.5 S
		C945	OCKZTBU003C	SC E 472M 14.0BW7 250V BK7.5 S
		C945	OCKZTBU003C	SC E 472M 14.0BW7 250V BK7.5 S
		C951	OCE228EH630	2200UF KMG 25V M FM5 BULK
		C952	OCE227CH638	220UF SHL,SD 25V M FM5 TP 5
		C953	OCE107CF638	100UF SHL,SD 16V M FM5 TP 5
		C954	OCE108ED618	1000UF KMG 10V M FL TP 5
		C971	OCE476EN618	47UF KMG 100V M FL TP 5
		C999	OCE337EN630	330UF KMG 100V M FM5 BULK

DATE: 2002. 04. 15.				
*S	*AL	LOC. NO.	PART NO.	DESCRIPTION / SPECIFICATION
DIODEs				
		D201	ODL305029BA	LTL-305DJ-0C2 TP LITEON GREEN/
		D301	ODS141489AB	1N4148 TP GRANDE DO-34 500MW 1
		D302	ODS141489AB	1N4148 TP GRANDE DO-34 500MW 1
		D303	ODS141489AB	1N4148 TP GRANDE DO-34 500MW 1
		D304	ODS141489AB	1N4148 TP GRANDE DO-34 500MW 1
		D305	ODS141489AB	1N4148 TP GRANDE DO-34 500MW 1
		D306	ODS141489AB	1N4148 TP GRANDE DO-34 500MW 1
		D307	ODS124409AA	1SS244 TP ROHM KOREA
		D308	ODS124409AA	1SS244 TP ROHM KOREA
		D309	ODS124409AA	1SS244 TP ROHM KOREA
		D310	ODS124409AA	1SS244 TP ROHM KOREA
		D311	ODS124409AA	1SS244 TP ROHM KOREA
		D312	ODS124409AA	1SS244 TP ROHM KOREA
		D313	ODS124409AA	1SS244 TP ROHM KOREA
		D314	ODS124409AA	1SS244 TP ROHM KOREA
		D315	ODS124409AA	1SS244 TP ROHM KOREA
		D316	6210TCE003J	BAS2550T BO SUNG 2550MM AXIAL5
		D317	ODS141489AB	1N4148 TP GRANDE DO-34 500MW 1
		D401	ODS141489AB	1N4148 TP GRANDE DO-34 500MW 1
		D402	ODD140009AA	EK14 V(1) TP SANKEN E/EO-TMD 4
		D403	ODRGS00149A	1N5817 GENERAL SEMICONDUCTOR T
		D512	ODS141489AB	1N4148 TP GRANDE DO-34 500MW 1
		D701	ODS141489AB	1N4148 TP GRANDE DO-34 500MW 1
		D702	ODS124409AA	1SS244 TP ROHM KOREA
		D704	0IPMGSK004A	STR-G8644D(LF1140) SANKEN 5P S
		D705	ODR140059DA	1N4005TB52 TP LITEON DO41 600V
		D706	ODR359150AA	BY359F-1500 BK PHILIPS SOD10
		D709	ODR400409AB	UF4004 TP G.I DO204AL 400V 1A
		D710	ODR320400AA	S3L20U-4004P15 BK SHINDENGEN N
		D711	ODS141489AB	1N4148 TP GRANDE DO-34 500MW 1
		D712	ODR100009CA	RGP10G TP GULF SEMICONDUCTOR L
		D714	ODS141489AB	1N4148 TP GRANDE DO-34 500MW 1
		D715	ODS141489AB	1N4148 TP GRANDE DO-34 500MW 1
		D716	ODR140059DA	1N4005TB52 TP LITEON DO41 600V
		D717	ODR140059DA	1N4005TB52 TP LITEON DO41 600V
		D718	ODR140059DA	1N4005TB52 TP LITEON DO41 600V
		D719	ODR100009DA	RGP10J TP GULF SEMICONDUCTOR L
		D720	ODS141489AB	1N4148 TP GRANDE DO-34 500MW 1
		D721	ODR100009CA	RGP10G TP GULF SEMICONDUCTOR L
		D723	ODS141489AB	1N4148 TP GRANDE DO-34 500MW 1
		D724	ODR140059DA	1N4005TB52 TP LITEON DO41 600V
		D725	ODS124409AA	1SS244 TP ROHM KOREA
		D730	971-0016	TIN HDC 0.60H
		D735	ODR140059DA	1N4005TB52 TP LITEON DO41 600V
		D741	ODS141489AB	1N4148 TP GRANDE DO-34 500MW 1
		D767	ODR100009DA	RGP10J TP GULF SEMICONDUCTOR L
		D768	971-0016	TIN HDC 0.60H
		D801	ODS141489AB	1N4148 TP GRANDE DO-34 500MW 1
		D802	ODS141489AB	1N4148 TP GRANDE DO-34 500MW 1
		D821	ODS141489AB	1N4148 TP GRANDE DO-34 500MW 1
		D900	ODD360000DA	D3SBA60 BK SHINDENGEN 600V 2
		D902	ODR153979AA	1N5397GP TP G.I DO201AD 600V 1
		D903	ODR100009CA	RGP10G TP GULF SEMICONDUCTOR L
		D905	ODD400709CB	UF4007 TP G.I DO204AL 1000V 1
		D906	ODS141489AB	1N4148 TP GRANDE DO-34 500MW 1
		D908	ODS141489AB	1N4148 TP GRANDE DO-34 500MW 1
		D941	ODRGS00330A	RGP15D(L-5700) GENERAL SEMICON
		D942	ODRGS00089A	SB1H100 GENERAL SEMICONDUCTOR
		D951	ODR540400AA	UF5404L BK G.I DO201AD 400V 3A
		D952	ODS141489AB	1N4148 TP GRANDE DO-34 500MW 1
		D961	ODRGS00090A	31GF6L-5701 GENERAL SEMICONDUCT

DATE: 2002. 04. 15.

*S	*AL	LOC. NO.	PART NO.	DESCRIPTION / SPECIFICATION
		D962	0DRGS00090A	31GF6L-5701 GENERAL SEMICONDUCTOR
		D971	0DR100009DA	RGF10J TP GULF SEMICONDUCTOR L
		ZD201	0DZ560009AG	GDZJ5.6B TP GRANDE DO-34 500MW
		ZD202	0DZ560009AG	GDZJ5.6B TP GRANDE DO-34 500MW
		ZD203	0DZ560009AG	GDZJ5.6B TP GRANDE DO-34 500MW
		ZD301	0DZ560009AG	GDZJ5.6B TP GRANDE DO-34 500MW
		ZD302	0DZ560009AG	GDZJ5.6B TP GRANDE DO-34 500MW
		ZD401	0DZ560009AG	GDZJ5.6B TP GRANDE DO-34 500MW
		ZD402	0DZ560009AG	GDZJ5.6B TP GRANDE DO-34 500MW
		ZD404	0DZ560009AG	GDZJ5.6B TP GRANDE DO-34 500MW
		ZD405	0DZ560009AG	GDZJ5.6B TP GRANDE DO-34 500MW
		ZD406	0DZ560009AG	GDZJ5.6B TP GRANDE DO-34 500MW
		ZD407	0DZ560009AG	GDZJ5.6B TP GRANDE DO-34 500MW
		ZD410	0DZ560009AG	GDZJ5.6B TP GRANDE DO-34 500MW
		ZD411	0DZ560009AG	GDZJ5.6B TP GRANDE DO-34 500MW
		ZD701	0DZ110009CF	GDZJ11B TP GRANDE DO34 0.5W 11
		ZD702	0DZ560009AG	GDZJ5.6B TP GRANDE DO-34 500MW
		ZD705	0DZ510009BE	GDZ5.1B TP GRANDE DO34 500MW 5
		ZD901	0DZ560009AG	GDZJ5.6B TP GRANDE DO-34 500MW
		ZD902	0DZ510009BE	GDZ5.1B TP GRANDE DO34 500MW 5

ICs

*S	*AL	LOC. NO.	PART NO.	DESCRIPTION / SPECIFICATION
		IC301	0IPRPNV008A	NT68272-20018 NOVATEK 16,DIP S
		IC302	0IPRPNS003A	LM1269NA NATIONAL SEMICONDUCTO
		IC303	0IPRPNS004A	LM2467TA NATIONAL SEMICONDUCTO
		IC304	0IPRPNS005A	LM2480NA NATIONAL SEMICONDUCTO
		IC401	0IZZTSZ176A	SS 42PIN ST COMPAQ 4KEY CA-110
		IC402	0ISG240860A	M24C08-BN6 8DIP BK 8K SERIAL I
		IC403	0IKE704200H	KIA7042AP TO-92 TP 4.2 VOLT.
		IC601	0IPH486600C	TDA4866J 9P ST VERTICAL OUTPUT
		IC701	0IPRPPH008A	TDA4857PS(V2) PHILIPS SDIP32 S
		IC901	0IPMGSK004A	STR-G8644D(LF1140) SANKEN 5P S

COILS & COREs

*S	*AL	LOC. NO.	PART NO.	DESCRIPTION / SPECIFICATION
		L301	0LA0560K119	0.56UH K 2.3*3.4 TP
		L302	0LA0560K119	0.56UH K 2.3*3.4 TP
		L303	0LA0560K119	0.56UH K 2.3*3.4 TP
		L304	0LA1000K119	100UH K 2.3*3.4 TP
		L311	0LA0680K119	0.68UH K 2.3*3.4 TP
		L312	0LA0680K119	0.68UH K 2.3*3.4 TP
		L313	0LA0680K119	0.68UH K 2.3*3.4 TP
		L501	0LA1000K119	100UH K 2.3*3.4 TP
		L502	0LA1000K119	100UH K 2.3*3.4 TP
		L702	6140TBZ025C	DR14*20 150UH 0.12*25MM 51T H-
		L703	6140TYZ011A	DR 14*15-C5.2 14*9T 4.5UH 0.12
		L705	6140TBZ026C	DR15*18-C9.8 100UH 0.1*30MM 40
		L901	6200TLS004B	SQE2424 15MH 0.55MM 70T CB775C
		FB201	6210TCE003J	BAS2550T BO SUNG 2550MM AXIAL5
		FB301	6210TCE003F	BRD3580B BO SUNG 3580MM RADIAL
		FB302	6210TCE003J	BAS2550T BO SUNG 2550MM AXIAL5
		FB303	6210TCE003J	BAS2550T BO SUNG 2550MM AXIAL5
		FB304	6210TCE003J	BAS2550T BO SUNG 2550MM LPD CDT
		FB304	971-0016	TIN HDC 0.60H TECO CDT
		FB305	6210TCE003J	BAS2550T BO SUNG 2550MM AXIAL5
		FB306	6210TCE003N	BRD3565B BO SUNG 3565MM RADIAL
		FB308	6210TCE003G	BRS3550B BO SUNG 3550MM RADIAL
		FB309	971-0016	TIN HDC 0.60H
		FB310	6210TCE003A	BRD3510B BO SUNG 3510MM RADIAL
		FB311	6210TCZ001J	BAS3550T(125-022J) BO SUNG RH
		FB312	6210TCZ001J	BAS3550T(125-022J) BO SUNG RH

DATE: 2002. 04. 15.

*S	*AL	LOC. NO.	PART NO.	DESCRIPTION / SPECIFICATION
		FB313	6210TCZ001J	BAS3550T(125-022J) BO SUNG RH
		FB314	6210TCE003J	BAS2550T BO SUNG 2550MM AXIAL5
		FB401	6210TCE003J	BAS2550T BO SUNG 2550MM AXIAL5
		FB402	6210TCE003J	BAS2550T BO SUNG 2550MM AXIAL5
		FB403	6210TCE003J	BAS2550T BO SUNG 2550MM AXIAL5
		FB701	6210TCE003J	BAS2550T BO SUNG 2550MM AXIAL5
		FB703	6210TCE003B	BRS3580B BO SUNG 3580MM RADIAL
		FB705	6210TCE003L	BAS3580T BO SUNG 3580MM AXIAL5
		FB901	6210TCE003P	BRS2550B BO SUNG 2550MM RADIAL
		FB904	6210TCE003K	BAS3550T BO SUNG 3550MM AXIAL5
		FB913	6210TCE003P	BRS2550B BO SUNG 2550MM RADIAL
		FB921	6210TCE003A	BRD3510B BO SUNG 3510MM RADIAL
		FB922	6210TCE003H	BAS3510T BO SUNG 3510MM AXIAL5
		FB923	6210TCE003F	BRD3580B BO SUNG 3580MM RADIAL
		FB951	6210TCE003J	BAS2550T BO SUNG 2550MM AXIAL5

TRANSISTOR

*S	*AL	LOC. NO.	PART NO.	DESCRIPTION / SPECIFICATION
		Q501	0TR320209AA	KTC3202-Y(KTC1959) TP KEC TO92
		Q502	0TR127009AA	KTA1270-Y(KTA562TM) TP KEC TO9
		Q503	0TR319809AA	KTC3198-Y(KTC1815) TP KEC TO92
		Q701	0TR200009AB	KTC200-Y TP KEC TO92 NPN
		Q706	0TR580301AA	FAIRCHILD KSC5803(TBTU) ST TO-
		Q707	0TR127009AA	KTA1270-Y(KTA562TM) TP KEC TO9
		Q708	0TR127009AA	KTA1270-Y(KTA562TM) TP KEC TO9
		Q709	0TR141300AB	KTD1413 BK KEC TO220I S NPN
		Q710	0TR440009CA	KSP44 TP SAMSUNG
		Q711	0TF630000CA	IRFS630A BK SAMSUNG 200V 6.5A
		Q712	0TF630000CA	IRFS630A BK SAMSUNG 200V 6.5A
		Q713	0TF630000CA	IRFS630A BK SAMSUNG 200V 6.5A
		Q714	0TR319809AA	KTC3198-Y(KTC1815) TP KEC TO92
		Q715	0TR319809AA	KTC3198-Y(KTC1815) TP KEC TO92
		Q716	0TR319809AA	KTC3198-Y(KTC1815) TP KEC TO92
		Q719	0TF630000CA	IRFS630A BK SAMSUNG 200V 6.5A
		Q720	0TR390409CA	2N3904 TP SAMSUNG TO92 NPN
		Q722	0TR319809AB	KTC3198-GR(KTC1815) TP KEC TO9
		Q723	0TR126609AA	KTA1266-Y(KTA1015) TP KEC TO92
		Q799	0TR920009AB	KSP92 TP SAMSUNG TO92 HIGH VOL
		Q821	0TR216101AA	KTD2161-Y ST KEC TO220AB NPN T
		Q903	0TRFC10003A	FAIRCHILD KSD882Y-S ST TO126 4
		Q903	4921TKK356B	KSD882 C009A CQ771G NT
		Q941	0TR319809AA	KTC3198-Y(KTC1815) TP KEC TO92
		Q942	0TR928009AB	KSA928A-Y TP SAMSUNG TO92L PNP
		Q951	0TR319809AA	KTC3198-Y(KTC1815) TP KEC TO92
		Q952	0TR928009AB	KSA928A-Y TP SAMSUNG TO92L PNP
		Q953	0TR319809AA	KTC3198-Y(KTC1815) TP KEC TO92

RESISTORs

*S	*AL	LOC. NO.	PART NO.	DESCRIPTION / SPECIFICATION
		R201	0RD1001Q609	1K 1/4W(3 5% TA52
		R202	0RD1100Q609	110 1/4W(3 5% TA52
		R203	0RD1001Q609	1K 1/4W(3 5% TA52
		R204	0RD1100Q609	110 1/4W(3 5% TA52
		R205	0RD9100Q609	910 1/4W(3 5% TA52
		R206	0RD6800Q609	680 1/4W(3 5% TA52
		R210	0RD2200Q609	220 1/4W(3 5% TA52
		R211	0RD2200Q609	220 1/4W(3 5% TA52
		R301	0RD0752Q609	75 1/4W(3 5% TA52
		R302	0RD0752Q609	75 1/4W(3 5% TA52
		R303	0RD0752Q609	75 1/4W(3 5% TA52
		R304	0RN1202F409	12K 1/6W 1% TA52
		R305	0RD5601Q609	5.60K 1/4W(3 5% TA52

DATE: 2002. 04. 15.

*S	*AL	LOC. NO.	PART NO.	DESCRIPTION / SPECIFICATION
		R306	ORD5601Q609	5.60K 1/4W(3 5% TA52
		R307	ORD1004Q609	1M OHM 1/4 W (3.4) 5% TA52
		R310	ORD1002Q609	10K 1/4W(3 5% TA52
		R311	ORD1502Q609	15K 1/4W(3 5% TA52
		R312	ORD1001Q609	1K 1/4W(3 5% TA52
		R314	ORD1000Q609	100 1/4W(3 5% TA52
		R315	ORD1000Q609	100 1/4W(3 5% TA52
		R316	ORD1000Q609	100 1/4W(3 5% TA52
		R317	ORD1000Q609	100 1/4W(3 5% TA52
		R318	ORD1000Q609	100 1/4W(3 5% TA52
		R319	ORD1000Q609	100 1/4W(3 5% TA52
		R320	ORD2001Q609	2K 1/4W(3 5% TA52
		R321	ORD2200Q609	220 1/4W(3 5% TA52
		R322	ORD2200Q609	220 1/4W(3 5% TA52
		R323	ORD2200Q609	220 1/4W(3 5% TA52
		R324	ORD2200Q609	220 1/4W(3 5% TA52
		R327	ORD1001Q609	1K 1/4W(3 5% TA52
		R328	ORD1001Q609	1K 1/4W(3 5% TA52
		R329	ORD1001Q609	1K 1/4W(3 5% TA52
		R330	ORD1000Q609	100 1/4W(3 5% TA52
		R331	ORD1500Q609	150 1/4W(3 5% TA52
		R332	ORD1500Q609	150 1/4W(3 5% TA52
		R333	ORD1500Q609	150 1/4W(3 5% TA52
		R334	ORD3303Q609	330K 1/4W(3 5% TA52
		R335	ORD3303Q609	330K 1/4W(3 5% TA52
		R336	ORD3303Q609	330K 1/4W(3 5% TA52
		R337	ORD1000Q609	100 1/4W(3 5% TA52
		R340	ORN1002F409	10K 1/6W 1 TA52
		R341	ORD0332A609	33 OHM 1/2 W (7.0) 5% TA52
		R342	ORD0332A609	33 OHM 1/2 W (7.0) 5% TA52
		R343	ORD0332A609	33 OHM 1/2 W (7.0) 5% TA52
		R344	ORD0332Q609	33 1/4W(3 5% TA52
		R345	ORD0332Q609	33 1/4W(3 5% TA52
		R346	ORD0332Q609	33 1/4W(3 5% TA52
		R347	ORD1200Q609	120 1/4W(3 5% TA52
		R348	ORC9104A609	9.1M OHM 1/2 W(7.0) 5% TA52
		R388	ORD1000Q609	100 1/4W(3 5% TA52
		R389	ORD1000Q609	100 1/4W(3 5% TA52
		R390	ORD1000Q609	100 1/4W(3 5% TA52
		R401	ORD1000Q609	100 1/4W(3 5% TA52
		R402	ORD1002Q609	10K 1/4W(3 5% TA52
		R403	ORD2200Q609	220 1/4W(3 5% TA52
		R404	ORD1000Q609	100 1/4W(3 5% TA52
		R405	ORD1000Q609	100 1/4W(3 5% TA52
		R406	ORD2001Q609	2K 1/4W(3 5% TA52
		R407	ORD2001Q609	2K 1/4W(3 5% TA52
		R408	ORD3302Q609	33K 1/4W(3 5% TA52
		R409	ORD1300Q609	130 1/4W(3 5% TA52
		R410	ORD1300Q609	130 1/4W(3 5% TA52
		R412	ORD2001Q609	2K 1/4W(3 5% TA52
		R413	ORD1001Q609	1K 1/4W(3 5% TA52
		R414	ORD1001Q609	1K 1/4W(3 5% TA52
		R415	ORD1001Q609	1K 1/4W(3 5% TA52
		R416	ORD1801Q609	1.80K 1/4W(3 5% TA52
		R417	ORD1001Q609	1K 1/4W(3 5% TA52
△		R418	ORD3901Q609	3.90K 1/4W(3 5% TA52
		R419	ORD1002Q609	10K 1/4W(3 5% TA52
		R421	ORD1002Q609	10K 1/4W(3 5% TA52
△		R422	ORD1001Q609	1K 1/4W(3 5% TA52
		R423	ORD5600Q609	560 1/4W(3 5% TA52
		R430	ORD1000Q609	100 1/4W(3 5% TA52
		R431	ORD1000Q609	100 1/4W(3 5% TA52

DATE: 2002. 04. 15.

*S	*AL	LOC. NO.	PART NO.	DESCRIPTION / SPECIFICATION
		R432	ORD1000Q609	100 1/4W(3 5% TA52
		R433	ORD1202Q609	12K 1/4W(3 5% TA52
		R434	ORD1202Q609	12K 1/4W(3 5% TA52
		R445	ORD1002Q609	10K 1/4W(3 5% TA52 TECO CDT
		R446	ORD1002Q609	10K 1/4W(3 5% TA52 LPD CDT
		R501	ORD0102A609	10 OHM 1/2 W (7.0) 5% TA52
		R508	ORD4702Q609	47K 1/4W(3 5% TA52
		R515	ORD1502Q609	15K 1/4W(3 5% TA52
		R597	ORD3902Q609	39K 1/4W(3 5% TA52
		R598	ORD6801Q609	6.80K 1/4W(3 5% TA52
		R599	ORD0202Q609	20 1/4W(3 5% TA52
		R601	ORD1001Q609	1K 1/4W(3 5% TA52
		R602	ORD1001Q609	1K 1/4W(3 5% TA52
		R603	ORN0390H609	0.39 1/2W 5 TA52
		R604	ORD0111A609	1.1 OHM 1/2 W (7.0) 5% TA52
		R605	ORD0102A609	10 OHM 1/2 W (7.0) 5% TA52
		R606	ORD1000A609	100 OHM 1/2 W (7.0) 5% TA52
		R607	ORN5101F409	5.10K 1/6W 1% TA52
		R608	ORD2700A609	270 OHM 1/2 W (7.0) 5% TA52 LPD CDT
		R608	ORD2000A609	200 OHM 1/2 W (7.0) 5% TA52 TECO CDT
		R610	ORD1101Q609	1.1K OHM 1/4 W (3.4) 5% TA52
		R612	ORN5101F409	5.10K 1/6W 1% TA52
		R613	ORD1801Q609	1.80K 1/4W(3 5% TA52
		R700	ORX0221K607	2.2 OHM 2 W 5% TA62
		R701	ORD1500A609	150 OHM 1/2 W (7.0) 5% TA52
		R702	ORD5601Q609	5.60K 1/4W(3 5% TA52
		R703	ORD0272Q609	27 OHM 1/4 W (3.4) 5% TA52
	△	R704	ORD3601Q609	3.60K 1/4W(3 5% TA52
		R705	ORD1602Q609	16K 1/4W(3 5% TA52
		R706	ORN2701F409	2.70K 1/6W 1% TA52
		R707	ORN3301F409	3.30K 1/6W 1% TA52
		R708	ORN1001F409	1K 1/6W 1% TA52
		R709	ORD2202Q609	22K 1/4W(3 5% TA52
		R710	ORD1000Q609	100 1/4W(3 5% TA52
		R711	ORD1000Q609	100 1/4W(3 5% TA52
		R712	ORD5100Q609	510 1/4W(3 5% TA52
		R713	971-0016	TIN HDC 0.60H
	△	R714	ORN1501F409	1.5K 1/6W 1 TA52
	△	R714-1	ORN3001F409	3K 1/6W 1% TA52
	△	R714-2	ORN6200F409	620 1/6W 1% TA52
	△	R715	ORD2702Q509	27K OHM 1/4 W(3.4) 2% TA52
		R716	ORD1004Q609	1M OHM 1/4 W (3.4) 5% TA52
		R717	ORD6801Q609	6.80K 1/4W(3 5% TA52
		R718	971-0016	TIN HDC 0.60H
		R719	ORD4701Q609	4.70K 1/4W(3 5% TA52
		R720	ORC1205Q609	12M OHM 1/4 W(3.4) 5% TA52
		R721	ORD1001Q609	1K 1/4W(3 5% TA52
		R723	ORD1001Q609	1K 1/4W(3 5% TA52
		R724	ORD1001Q609	1K 1/4W(3 5% TA52
		R725	ORD1001Q609	1K 1/4W(3 5% TA52
		R726	ORD5102A609	51K OHM 1/2 W (7.0) 5% TA52
		R727	ORD1001Q609	1K 1/4W(3 5% TA52
		R728	ORX0242K665	24 OHM 2 W 5% SF LPD CDT
		R728	ORX0202K665	20 OHM 2 W 5% SF TECO CDT
		R729	ORD3000A609	300 OHM 1/2 W (7.0) 5% TA52
		R730	ORB0150K665	0.15 OHM 2 W 5% SF
		R731	ORD1002Q609	10K 1/4W(3 5% TA52
		R732	ORD6802Q509	68K OHM 1/4 W (3.4) 2% TA52
		R733	ORD1002Q609	10K 1/4W(3 5% TA52
		R734	ORD0222A609	22 OHM 1/2 W (7.0) 5% TA52
		R735	ORD1001Q609	1K 1/4W(3 5% TA52
		R736	ORX1501K665	1.5K OHM 2 W 5% SF

DATE: 2002. 04. 15.

*S	*AL	LOC. NO.	PART NO.	DESCRIPTION / SPECIFICATION
		R737	0RN0560H609	0.56 1/2W 5 TA52
		R738	0RN0560H609	0.56 1/2W 5 TA52
		R740	0RD0271A609	2.7 OHM 1/2 W (7.0) 5% TA52
		R741	0RD1000Q609	100 1/4W(3 5% TA52
		R742	0RD4702Q609	47K 1/4W(3 5% TA52
		R743	0RD2701Q509	2.7K OHM 1/4 W(3.4) 2% TA52
		R744	0RX3900J609	390 OHM 1 W 5% TA52
		R745	0RD4702Q609	47K 1/4W(3 5% TA52
		R746	0RD2201Q609	2.20K 1/4W(3 5% TA52
		R747	0RD3001Q609	3K 1/4W(3 5% TA52
		R748	0RD4702Q609	47K 1/4W(3 5% TA52
		R749	0RD2201Q609	2.20K 1/4W(3 5% TA52
		R750	0RD3001Q609	3K 1/4W(3 5% TA52
		R751	0RX3900J609	390 OHM 1 W 5% TA52
		R752	0RD2201Q609	2.20K 1/4W(3 5% TA52
		R753	0RD3001Q609	3K 1/4W(3 5% TA52
		R754	0RX4300K607	430 OHM 2 W 5% TA62
		R755	0RD0471Q609	4.70 1/4W(3 5% TA52
		R756	0RD2202A609	22K OHM 1/2 W (7.0) 5% TA52
		R757	0RD0222A609	22 OHM 1/2 W (7.0) 5% TA52
		R758	0RN1303F409	130K 1/6W 1% TA52
		R759	0RD1202Q509	12K OHM 1/4 W (3.4) 2% TA52 LPD CDT
		R759	0RD1302Q509	13K OHM 1/4 W (3.4) 2% TA52 TECO CDT
		R760	0RD5103Q609	510K 1/4W(3 5% TA52
		R761	0RD3001Q609	3K 1/4W(3 5% TA52
		R762	0RD3001Q609	3K 1/4W(3 5% TA52
		R763	0RD3001Q609	3K 1/4W(3 5% TA52
		R764	0RD6201Q609	6.20K 1/4W(3 5% TA52
		R766	0RD0752Q609	75 1/4W(3 5% TA52
		R768	0RD6803A609	680K OHM 1/2 W (7.0) 5% TA52
		R771	0RD3301Q609	3.30K 1/4W(3 5% TA52
		R772	0RD2702Q509	27K OHM 1/4 W(3.4) 2% TA52
		R773	0RD4302A609	43K OHM 1/2 W(7.0) 5.00% TA52 LPD CDT
		R773	0RD2402A609	24K OHM 1/2 W (7.0) 5% TA52 TECO CDT
		R775	0RD4701Q609	4.70K 1/4W(3 5% TA52
		R778	0RD4301Q609	4.30K 1/4W(3 5% TA52
		R779	0RD4701Q609	4.70K 1/4W(3 5% TA52
		R782	0RD3301A609	3.3K OHM 1/2 W(7.0) 5.00% TA52
		R784	0RD1000Q609	100 1/4W(3 5% TA52
		R789	0RD6800Q609	680 1/4W(3 5% TA52
		R793	0RD4702Q609	47K 1/4W(3 5% TA52
		R797	0RD1501Q609	1.50K 1/4W(3 5% TA52
		R798	0RD2001Q609	2K 1/4W(3 5% TA52
		R799	0RD1502Q609	15K 1/4W(3 5% TA52
		R801	0RD1802Q609	18K 1/4W(3 5% TA52 LPD CDT
		R801	0RD1602Q609	16K 1/4W(3 5% TA52 TECO CDT
		R802	0RD3302Q609	33K 1/4W(3 5% TA52
		R803	0RD2001Q609	2K 1/4W(3 5% TA52
		R805	0RD2001Q609	2K 1/4W(3 5% TA52
		R806	0RD4702Q609	47K 1/4W(3 5% TA52
		R808	0RD6802Q609	68K 1/4W(3 5% TA52
		R809	0RMZTW001G	RWR SMART 10HM 5 W 5% PD TYPE
		R813	0RD4302A609	43K OHM 1/2 W(7.0) 5.00% TA52
		R814	0RD1002Q609	10K 1/4W(3 5% TA52
△		R816	0RN3601F409	3.6K 1/6W 1 TA52
△		R818	0RN2202F409	22K 1/6W 1% TA52
		R819	0RD4702Q609	47K 1/4W(3 5% TA52
		R821	0RD3001Q609	3K 1/4W(3 5% TA52
		R822	0RX0122K607	12 OHM 2 W 5% TA62
		R823	0RX0122K665	12 OHM 2 W 5% SF
		R824	0RX0122K665	12 OHM 2 W 5% SF
		R831	0RD1002Q609	10K 1/4W(3 5% TA52

DATE: 2002. 04. 15.

*S	*AL	LOC. NO.	PART NO.	DESCRIPTION / SPECIFICATION
		R901	0RD4703A609	470K OHM 1/2 W (7.0) 5% TA52
		R903	0RD5600A609	560 OHM 1/2 W (7.0) 5% TA52
		R904	0RX1503K607	150K OHM 2 W 5% TA62
		R905	0RD2201Q609	2.20K 1/4W(3 5% TA52
		R906	0RD6200Q609	620 1/4W(3 5% TA52
		R907	0RN0220H609	0.22 1/2W 5% TA52
		R908	0RN0220H609	0.22 1/2W 5% TA52
		R910	0RX9102J609	91K OHM 1 W 5% TA52
		R911	0RD5602Q609	56K OHM 1/4 W(3.4) 5.00% TA52
		R912	0RX9102J609	91K OHM 1 W 5% TA52
		R925	0RB0120K607	0.12 OHM 2 W 5% TA62
		R941	0RN0220H609	0.22 1/2W 5% TA52
		R944	0RD4700A609	470 OHM 1/2 W (7.0) 5% TA52
		R945-1	0RD4701Q609	4.70K 1/4W(3 5% TA52
		R951	0RN0220H609	0.22 1/2W 5% TA52
		R952	0RD4702A609	47K OHM 1/2 W (7.0) 5% TA52
		R953	0RX4700J609	470 OHM 1 W 5% TA52
		R954	0RD4701Q609	4.70K 1/4W(3 5% TA52
		R955	0RD4701Q609	4.70K 1/4W(3 5% TA52
		R956	0RD4702Q609	47K 1/4W(3 5% TA52
		R957	0RD0472A609	47 OHM 1/2 W (7.0) 5% TA52
		R960	0RD2200A609	220 OHM 1/2 W (7.0) 5% TA52
		R967	971-0016	TIN HDC 0.60H
OTHERs				
		F901	0FZZTTH001D	TIME LAG HBC 3.15A/250V,215 3.
		J27	0RD0471Q609	4.70 1/4W(3 5% TA52
		J59	0RD1000Q609	100 1/4W(3 5% TA52
		J99	0RD1001Q609	1K 1/4W(3 5% TA52
		J103	0RD1501Q609	1.50K 1/4W(3 5% TA52
		RL901	6920TBB005A	ALA2PF12 MATSUSHITA 250V 5A 12
		SC301	6620TBD004A	GZS10-2-101 DUOLING(SANLING) 1
		SC901	6620TKB002B	SA-4S HUA JIE AC UNIVERSAL 3PI
		SG301	6918TRT005A	SSG-102-A0,1KV SMART RADIAL TA
		SG302	6918TRT005A	SSG-102-A0,1KV SMART RADIAL TA
		SG303	6918TRT005A	SSG-102-A0,1KV SMART RADIAL TA
△		SG304	6918TRT005A	SSG-102-A0,1KV SMART RADIAL TA
		SG305	6918TRT005A	SSG-102-A0,1KV SMART RADIAL TA
		SG701	6918TRT005A	SSG-102-A0,1KV SMART RADIAL TA
		SW201	140-058D	SKHV10911A LGEC NON 12 20 HORI
		SW202	140-058D	SKHV10911A LGEC NON 12 20 HORI
		SW203	140-058D	SKHV10911A LGEC NON 12 20 HORI
		SW204	140-058D	SKHV10911A LGEC NON 12 20 HORI
		T1	6631T11005D	1P W-T 520MM UL 1015 AWG 22 CB
△		T701	6174T11003E	"1054A,CB777G LG-PHILIPS 17"
		T702	6170TCZ006A	EE2218 2.3 MH D/FOCUS(CB775C),
		T703	6170TCZ001D	EI2218 4.0MH H-DRIVE,EB770G
		T901	6170TMZ132A	EER3541 150UH V-16PIN EB770G S
		TH901	6322B00002B	MZ72-9RM290V GAOLI 9OHM 20% 2P
		TH902	6322TA080BA	SCK-084 THINKING 8 ohm 15% 264
		X401	6202TTB003B	HC-49U HARMONY RADIAL 12MHZ 3

PIN CONFIGURATION

TDA4866J

Current Driven Vertical Deflection Booster

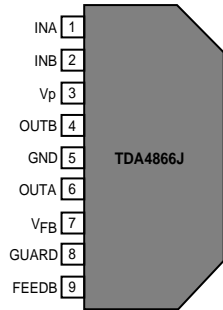
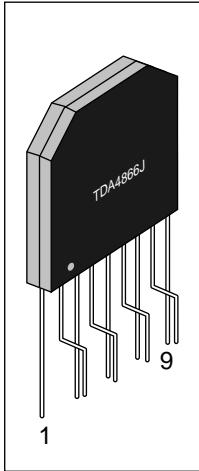

Pin Configuration

PIN	SYMBOL
1	INA
2	INB
3	V _P
4	OUTB
5	GND
6	OUTA
7	V _{FB}
8	GUARD
9	FEEDB

M24C08

Serial I²C BUS EEPROM

PSDIP8 (BN)
0.25mm Frame

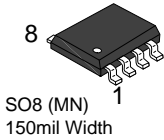
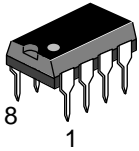

SO8 (MN)
150mil Width

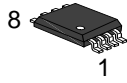

TSSOP8 (DW)
169mil Width

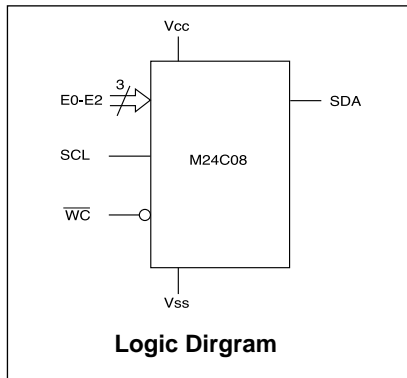

Logic Diagram

SYMBOL	DESCRIPTION
E0-E2	Chip Enable Input
SDA	Serial Data Address Input/Output
SCL	Serial Clock
WC	Write Control
V _{cc}	Supply Voltage
V _{ss}	Ground

LM2469 Monolithic Triple 9nS high Gain CRT Driver

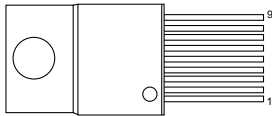

Connection Diagram

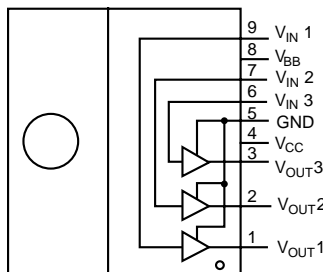

STR-G8644D

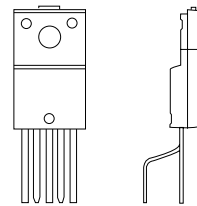

Block Diagram

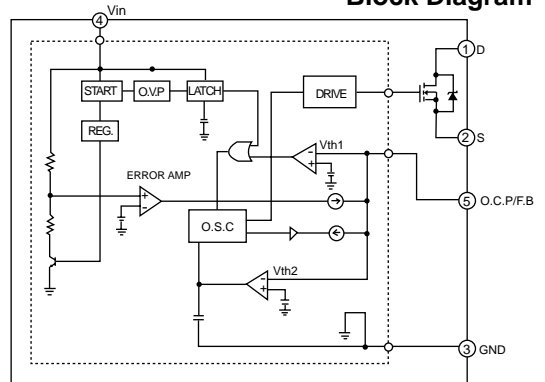

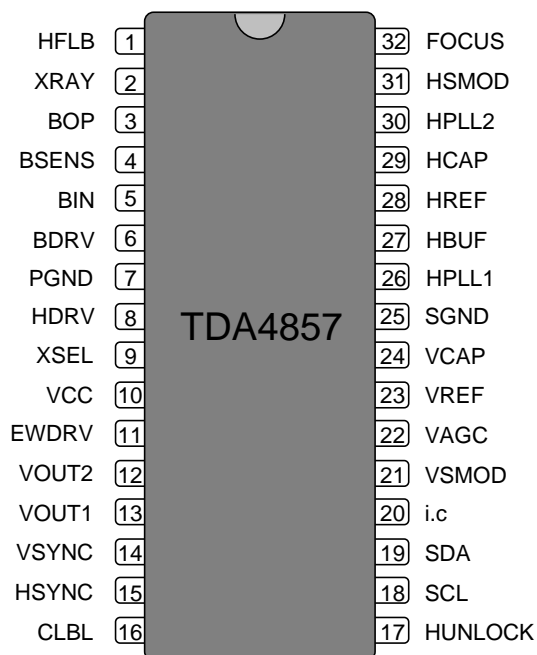
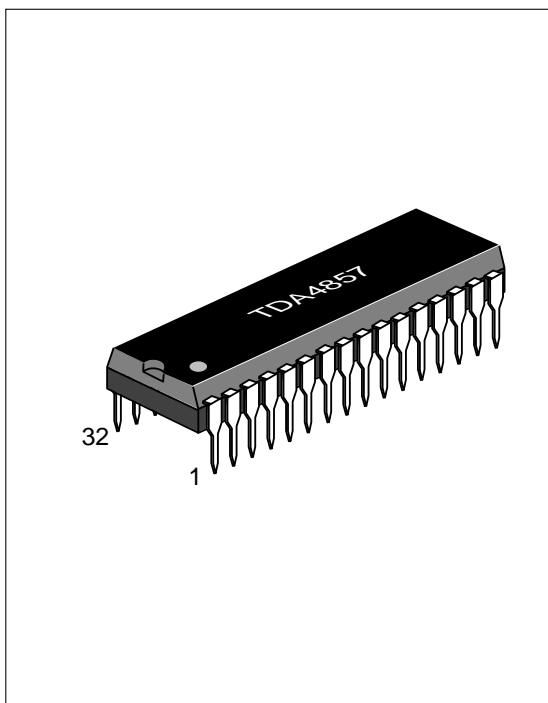

Pin Configuration

PIN	SYMBOL	DESCRIPTION	PIN	SYMBOL	DESCRIPTION
1	HFLB	Horizontal Flyback Input	17	HUNLOCK	H-Synchronization Unlock/Protection/V-Blanking Output
2	XRAY	X-ray Protection Input	18	SCL	I ² C-Bus Clock Input
3	BOP	B ⁺ Control OTA Output	19	SDA	I ² C-Bus Data Input
4	BSENS	B ⁺ Control Comparator Input	20	i.c	Internally connected; nite 1
5	BIN	B ⁺ Control OTA Input	21	VSMOD	Input for EHT Compensation (Via V-Size)
6	BDRV	B ⁺ Control Driver Output	22	VAGC	External Capacitor for V-Amplitude Control
7	PGND	Power Ground	23	VREF	External Resistor for Vertical Oscillator
8	HDRV	Horizontal Driver Output	24	VCAP	External Capacitor for Vertical Oscillator
9	XSEL	Select Input for X-ray reset	25	SGND	Signal Ground
10	Vcc	Supply Voltage	26	HPLL1	External Filter for PLL1
11	EWDRV	EW Waveform Output	27	HBUF	Buffered F/V Voltage Output
12	VOUT2	Vertical Output 2 (Ascending Sawtooth)	28	HREF	Reference Current for Horizontal Oscillator
13	VOUT1	Vertical Output 1 (Descending Sawtooth)	29	HCAP	External Capacitor for Horizontal Oscillator
14	VSYNC	Vertical Synchronization Input	30	HPLL 2	External Filter for PLL2 / Soft Start
15	HSYNC	Horizontal / Composite Synchronization Input	31	HSMOD	Input for EHT Compensation (Via H-Size)
16	CLBL	Video Clamping Pulse / V-Blanking Output	32	FOCUS	Output for Vertical Focus

- IIC-SDA
- IIC-SCL
- DDC-SDA
- DDC-SCL

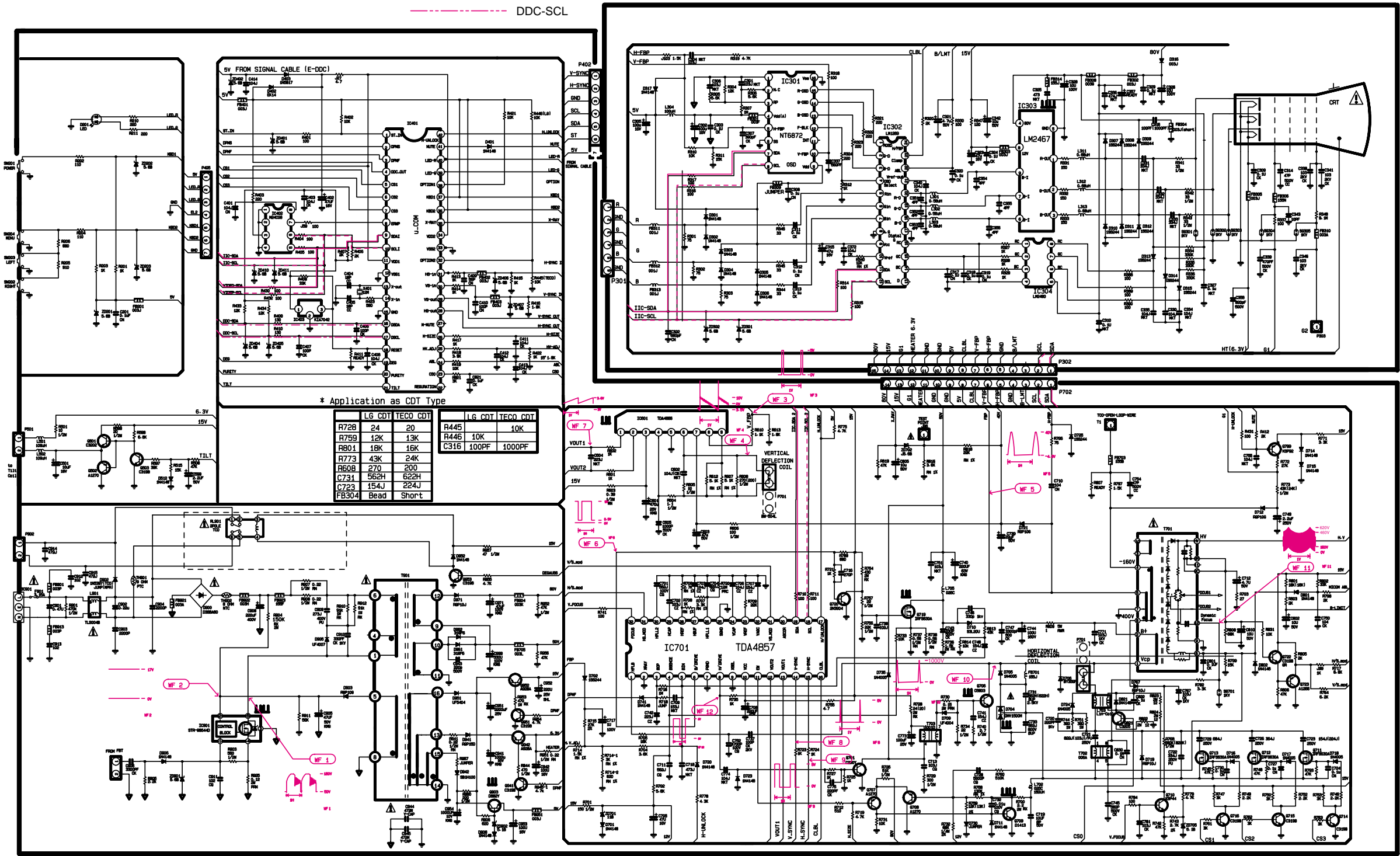

* Application as CDT Type

	LG CDT	TECO CDT		LG CDT	TECO CDT
R728	24	20	R445	10K	10K
R759	12K	13K	R446	10K	
R801	18K	16K	C316	100PF	1000PF
R773	43K	24K			
R608	270	200			
C731	562H	622H			
C723	154J	224J			
FB304	Bead	Short			

THE SYMBOL MARK OF THIS SCHEMATIC DIAGRAM INCORPORATES SPECIAL FEATURES IMPORTANT FOR PROTECTION FROM X-RADIATION, FILURE AND ELECTRICAL SHOCK HAZARDS. WHEN SERVICING IT IS ESSENTIAL THAT ONLY MANUFACTURERS SPECIFIED PARTS BE USED FOR THE CRITICAL COMPONENTS IN THE SYMBOL MARK OF THE SCHEMATIC.

COMPANY CONFIDENTIAL DO NOT COPY!

DATE	2002.04.03	REV	04
MODEL	CQ7716	Sheet	1 / 1 Page

NOTICE
 Since this is a basic schematic diagram, the value of components and some partial connection are subject to be changed for improvement without notice.

1. CONTROL BOARD (Component Side)

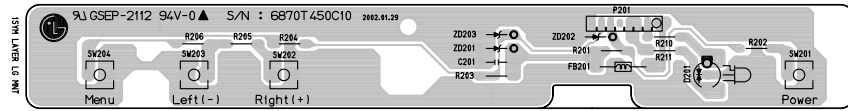

2. CONTROL BOARD (Solder Side)

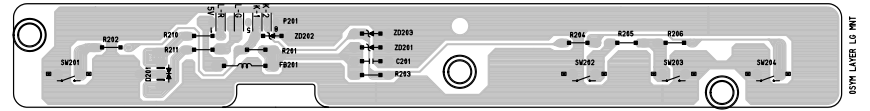

3. MAIN BOARD (Component Side)

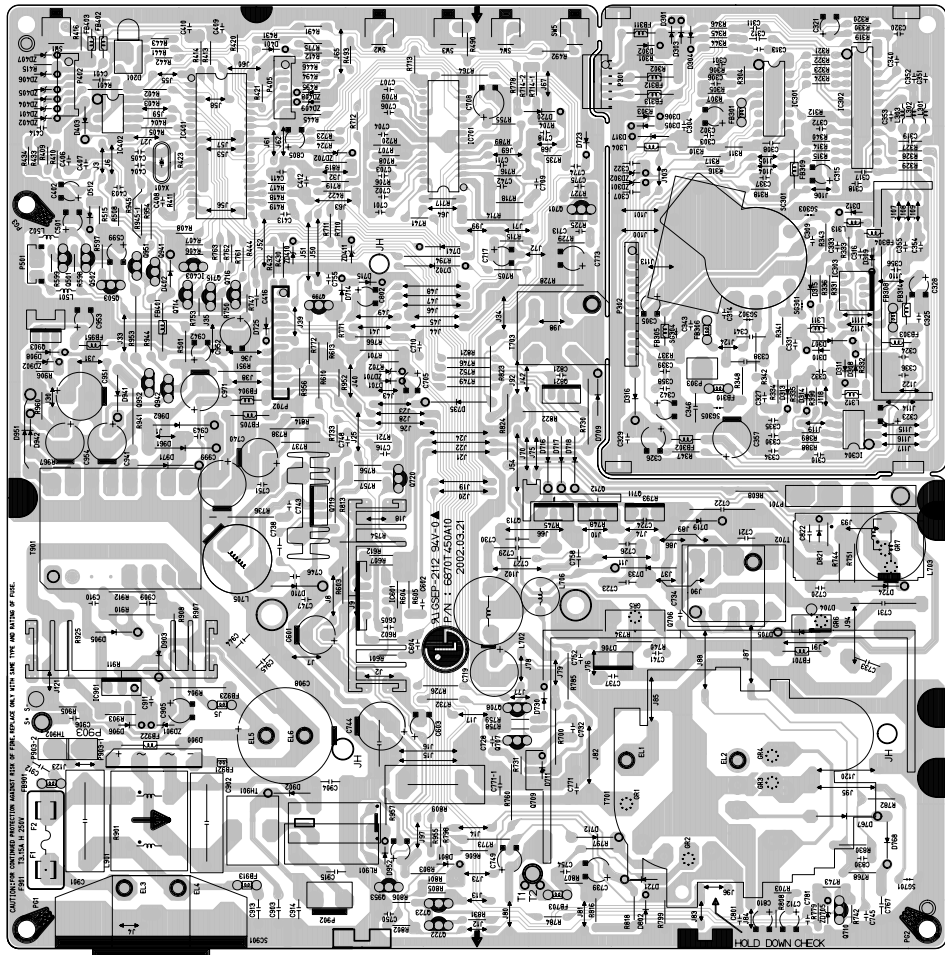

4. MAIN BOARD (Solder Side)

